

Level Plus[®]

Magnetostrictive Liquid Level Transmitters
with Temposonics[®] Technology

DDA Interface Manual
LP Series

Table of contents

1. Contact Information	3
2. Terms and Definitions	4
3. Introduction	6
4. Safety Instructions	6
5. Quick Start-Up Guide	6
5.1 Before You Begin	6
5.2 Quick Start-Up Procedure	6
6. Display Menu	6
6.1 Operation Modes	6
6.1.1 Run Mode	6
6.1.2 Program Mode	6
6.2 Display Diagram	7
6.3 Menu Structure	7
7. Alarms	7
8. Error Codes (Faults)	8
9. DDA Interface	8
10. Hardware and Software Environments	9
11. DDA Command Decoder Examples	9
12. DDA/Host Computer Communication Protocol	10
13. DDA Command Definitions	14
13.1 Special Control Commands	14
13.2 Level Commands	14
13.3 Temperature Commands	15
13.4 Multiple Output Commands	15
13.5 High-Level Memory Read Commands	16
13.6 High-Level Memory Write Commands	17
13.7 Diagnostic/Special Command Set	19
13.8 DDA Error Codes	19
14. LP Dashboard, Setup Software	20
14.1 Installing LP Dashboard	20
14.2 Home Screen	20
14.3 Configuration	21
14.4 Signal Settings	21
14.5 Level Settings	21
14.6 Temperature Settings	22
14.7 Flash Settings	22
14.8 Save Settings	23
14.9 Programming the Display	23
14.9.1 Data from Device Tab	23
14.9.2 Calibration	23
14.9.3 Factory	23

1. Contact information

United States

General

Tel: +1-919-677-0100
Fax: +1-919-677-2343
E-mail: info.us@mtssensors.com
<http://www.mtssensors.com>

Mailing and shipping address

MTS Systems Corporation
Sensors Division
3001 Sheldon Drive
Cary, North Carolina, 27513, USA

Customer service

Tel: +1-800-633-7609
Fax: +1-800-498-4442
E-mail: info.us@mtssensors.com

Technical support and applications

24 Hour Emergency Technical Support
Tel: +1-800-633-7609
e-mail: levelplus@mts.com

Germany

General

Tel.: +49-2351-9587-0
Fax: +49-2351-56491
e-mail: info.de@mtssensors.com
<http://www.mtssensors.com>

Mailing and shipping address

MTS Sensor Technologie, GmbH & Co. KG
Auf dem Schüffel 9
D - 58513 Lüdenscheid, Germany

Technical support and applications

Tel.: +49-2351-9587-0
e-mail: info.de@mtssensors.com
<http://www.mtssensors.com>

Japan

General

Tel.: +81-42-775-3838
Fax: +81-42-775-5512
e-mail: info.jp@mtssensors.com
<http://www.mtssensors.com>

Mailing and shipping address

MTS Sensors Technology Corporation
737 Aihara-machi, Machida-shi
Tokyo 194-0211, Japan

Technical support and applications

Tel.: +81-42-775-3838
Fax: +81-42-775-5512

2. Terms and definitions

6A Heavy Oils

'Generalized Crude Oils', Correction of Volume to 60 °F against API Gravity.

6B Light Oils

'Generalized Products', Correction of Volume to 60 °F against API Gravity.

6C Chemical

'Volume Correction Factors (VCF)' for individual and special applications, volume correction to 60 °F against thermal expansion coefficients.

6C Mod

An adjustable temperature reference for defining VCF.

A

API Gravity

The measure of how heavy or light a petroleum liquid is compared to water. Allowable values are 0 to 100 degrees *API* for (6A) and 0 to 85 degrees *API* for (6B).

D

DDA

'Direct Digital Access' – The proprietary digital protocol developed by MTS for use in intrinsically safe areas.

Density

Mass divided by the volume of an object at a specific temperature. The density value should be entered as lb / cu. ft..

E

Explosion proof

Type of protection based on enclosure in which the parts which can ignite an explosive gas atmosphere are placed within, and which can withstand the pressure developed during an internal explosion of an explosive mixture, and which prevents the transmission of the explosion to the explosive gas atmosphere surrounding the enclosure.

F

Flameproof

Type of protection based on enclosure in which the parts which can ignite an explosive gas atmosphere are placed within and which can withstand the pressure developed during an internal explosion of an explosive mixture, and which prevents the transmission of the explosion to the explosive gas atmosphere surrounding the enclosure.

FOUNDATION™ fieldbus

An all digital, serial, two-way communications system that serves as the base-level network in a plant or factory automation environment. Developed and administered by the fieldbus FOUNDATION™.

G

GOVI

'Gross Observed Volume of the Interface' – The total volume of the tank occupied by the interface liquid. The *GOVI* is only given when measuring two liquids and is calculated by subtracting the volume of the product from the total volume of liquid in the tank (*GOVT* – *GOVP*).

GOVP

'Gross Observed Volume of the Product' – The total volume of the tank occupied by the product liquid. When measuring only one liquid, it is also the total volume of liquid in the tank (*GOVT*). When measuring two liquids it is the total volume of liquid in the tank minus the volume of the interface liquid (*GOVT* – *GOVI*).

GOVT

'Total Gross Observed Volume' – The total volume of liquid in the tank. When measuring only one liquid it is equal to the volume of the product (*GOVP*). When measuring two liquids it is equal to the volume of the product and interface liquids (*GOVP* + *GOVI*).

GOVU

'Gross Observed Volume Ullage' – the difference in volume between the working capacity of a tank and the total volume in the tank (Working Capacity – *GOVT*).

H

HART®

A *Bidirectional communication protocol* that provides data access between intelligent field instruments and host systems.

I

Interface

Noun; The measurement of the level of one liquid when that liquid is below another liquid.

Interface

Adj.; The Software *Graphical User Interface* (GUI) that allows the user to access software protocols (*HART*, *DDA*, *MODBUS*).

Intrinsic safety

'Intrinsically safe' - Type of protection based on the restriction of electrical energy within apparatus of interconnecting wiring exposed to potentially explosive atmosphere to a level below that which can cause ignition by either sparking or heating effects.

M

Mass

The property of a body that causes it to have weight in a gravitational field, calculated by density at the reference temperature multiplied by the volume correction factor ($Density * VCF$).

MODBUS

A *serial communications protocol* published by Modicon in 1979 for use with its programmable logic controllers (PLCs). It has become a de facto standard communications protocol in industry, and is now the most commonly available means of connecting industrial electronic devices.

N

NEMA Type 4X

A product *Enclosure* intended for indoor or outdoor use primarily to provide a degree of protection against corrosion, windblown dust and rain, splashing water, and hose-directed water; and to be undamaged by the formation of ice on the enclosure. They are not intended to provide protection against conditions such as internal condensation or internal icing.

NPT

U.S. standard defining tapered pipe threads used to join pipes and fittings.

NSVP

'Net Standard Volume of the Product' – The temperature corrected volume for the product liquid in the tank, requires the transmitter to be ordered with temperature measurement capabilities. The *NSVP* is calculated by multiplying the volume of the product liquid by a volume correction factor based on temperature ($GOVP * VCF$).

R

Reference Temperature

The *temperature* at which the density measurement is given, the allowable values are 32 °F to 150 °F (0 °C to 66 °C).

S

Specific Gravity

The *density ratio* of a liquid to the density of water at the same conditions.

Sphere Radius

The *internal radius* of the sphere that contains the liquid, the value is used to calculate the volume along with the *Sphere Offset*.

Sphere Offset

An *offset value* that accounts for additional volume in a sphere from non-uniform sphere geometry, the value is used to calculate the volume along with the *Sphere Radius*.

Strap Table

A *table of measurement* correlating the height of a vessel to the volume that is contained at that height. The transmitter can contain up to 100 points.

T

TEC

'Thermal Expansion Coefficient' - a value correlating the change in temperature for an object with the change in its volume. Allowable values are 270.0 to 930.0. TEC units are in 10 E-6/Deg F.

Temperature Correction Method

One of five *product correction methods* used to correct the product volume in the tank due to changes in temperature from 60 °F including (*6A, 6B, 6C, 6C Mod, and Custom Table*).

V

Volume Calculation Mode

One of two methods use to calculate volume measurements from level measurements, including *Sphere* and *Strap Table*.

VCF

'Volume Correction Factor' – A table of measurements correlating temperature points with correction factors for the liquids expansion/contraction. The transmitter can contain up to 50 points.

W

Working Capacity

The *maximum volume of liquid* that the user desires for their vessel to hold, typically 80% of the vessels maximum volume before overflow.

3. Introduction

3.1 Purpose and use of this manual

Before starting the operation of the equipment read this documentation thoroughly and follow the safety information.

The content of this technical documentation and of its various annexes is intended to provide information on mounting, installation and commissioning by qualified service personnel according to IEC 60079-14 and/or MTS trained service technicians and local regulations.

3.2 Used symbols and warnings

Warnings are intended for your personal safety and for avoidance of damage to the described product or connected devices. In this documentation, safety information and warnings to avoid dangers that might affect the life and health of personnel or cause material damage are highlighted by the preceding pictogram, which is defined below.

Symbol	Meaning
NOTICE	This symbol is used to point to situations that may lead to material damage and/or personal injury.

4. Safety instructions

4.1 Intended use

The purpose of this document is to provide detailed information on the protocol interface. All safety related information is in the product specific operation manual. Consult the operation manual before connecting to the level transmitter.

5. Quick start-up guide

5.1 Before you begin

Note:

You must use a RS-485 converter with “Send Data Control” and the Set-up Software to ensure proper operation.

Example:
 B & B Electronics 485BAT3 (815-433-5100 www.bb-elec.com).
 FTDI USB-RS485-WE-1800-BT (www.ftdichip.com)

5.2 Quick start-up procedure

1. Connect +24 Vdc to terminals.
2. Connect data lines to terminals.
3. Connect the PC (or other device) to data lines.
(If you are using a PC, use a RS-232 to RS-485 converter. See Note above for more information.)
4. Turn on power to the transmitter.
5. Start the LP Dashboard. Select Com Port and Address. Factory default address is ‘192 ’ for DDA.

6. Change the address to one that is suitable for the installation network.
7. Verify proper operation of product and or interface floats and temperature.
8. Turn off power to the transmitter.
9. Remove data lines.
10. Install the transmitter into the vessel (see Operation Manual).
11. Reconnect power and data lines.
12. Calibrate current tank level using setup software (optional).
13. Verify communications with the host system.

Default communication parameters

DDA: 4800 BAUD 8, E, 1

6. Display Menu

All LP-Series liquid level transmitters are shipped with a Stylus (MTS Part # 254740) to be used for manipulating the display. For single and dual cavity housings, the Stylus is designed to allow for programming of the unit without removing the housing. When using the Stylus make sure to align the Stylus with the shape outline around the buttons in the same orientation. Failure to correctly align the Stylus can cause the display to not function properly.

Note:

Do not use any device other than the MTS Stylus to operate the display on the LP Series.

Note:

Improper use of the Stylus can cause the display to not function properly.

6.1 Operation Modes

The LP Series level transmitter runs in one of the following modes of operation. You can use these modes to calibrate and set up various operating parameters.

6.1.1 Run Mode

Run mode is the primary mode of operation. This mode will perform measurements, display data, and respond to DDA commands.

6.1.2 Program Mode

Program mode is the primary mode for commissioning and troubleshooting the level transmitter. The full menu and available functions are shown in section 6.3 Menu Structure. To enter program mode use the Stylus and press the Enter Key as shown in section 6.2 Display Diagram. Program Mode is protected by a password to keep unwarranted changes from occurring. The factory default password is 27513. When in program mode, remote communications are not functional. An automatic timeout feature is provided so that the transmitter does not remain inadvertently in program mode. The timeout is set for 1 minute before prompted for additional time. Total timeout is 2 minutes.

Note:

Whenever program mode is exited from the display the unit will reset itself to insure all changes have been accepted. The reset will take approximately 5 seconds before the level transmitter is able to respond to commands.

Note:

In program mode, the transmitter will not respond to incoming DDA commands. A busy error will be sent to the controller to notify the unit is in program mode. This function will prevent a user at a remote terminal from programming the unit while a user is accessing program mode from the display.

6.2 Display Diagram

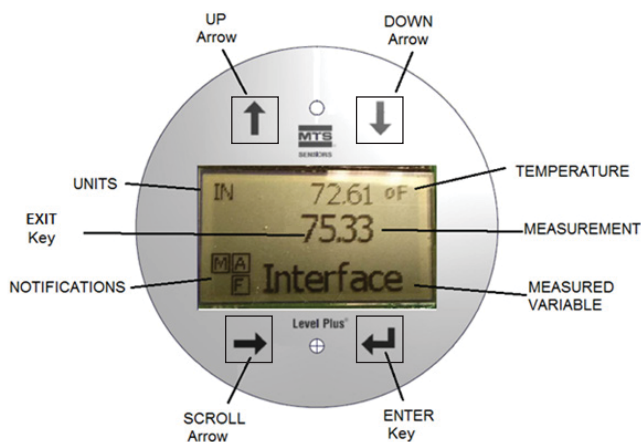

Fig. 1: DDA Display

- UP Arrow** – Used to move cursor on screen up and to increment number.
- DOWN Arrow** – Used to move cursor on screen down and to decrease number.
- SCROLL Arrow** – Used to move cursor on screen to the right, cursor will cycle back.
- ENTER Key** – Used to Enter Program Mode, select Highlighted Item, and Confirm Selection.
- EXIT Key** – Hidden key in the middle of the display that is used to exit menu at any time.
- MEASURED VARIABLE** – The process variable that is selected to display. The display will automatically scroll between selected variables.
- MEASUREMENT** – The numerical value for the MEASURED VARIABLE shown on the display.
- UNITS** – Unit of measurement for the MEASURED VARIABLE shown on the display.
- TEMPERATURE** – Average temperature for the product in the tank. Only shown if the level transmitter was purchased with temperature.
- NOTIFICATIONS** – Four squares with letters. Top left square will always be present indicating a D for DDA mode or a M for Modbus mode. Top right square, A, will only show when there is an alarm. Toggle the UP Arrow key to view alarms. Bottom right square, F, will only show when there is a fault. Toggle the DOWN Arrow key to view error codes. Bottom left square, P, will only show when the units is being programmed remotely.

6.3 Menu Structure

- Data From Device
 - Display
 - Units
 - Length Units
 - Temp Units
 - Address
 - Signal Strength
 - Prod Trig Lvl
 - Int Trig Lvl
- Calibrate
 - Product Level
 - Current Level
 - Offset
 - Interface Level
 - Current Level
 - Offset
- Factory
 - Settings
 - Gradient
 - Serial Number
 - HW Revision
 - SW Revision
 - SARA Blanking
 - Magnet Blanking
 - Gain
 - Min Trig Level
 - Temp Setup
 - Float Config
 - Auto Threshold
 - Reset to Factory

7. Alarms

The DDA output is equipped with several alarms that will be shown on the display. Use the stylus to tap the Up arrow to view alarms. The DDA output is set to fail high, greater than the order length, if there is an issue and the level value output cannot be trusted.

8. Error Codes (Faults)

Fault Code	Description	Corrective Action
101	Missing Magnet	<ul style="list-style-type: none"> • Verify Float Configuration is correct for the number of floats installed. • Verify Float(s) are not in inactive zone. • Verify Auto Threshold is enabled. • Cycle power to sensor. If proper operation is not restored, Contact Factory.
102	Internal Fault 1	Cycle power to sensor. If proper operation is not restored, Contact Factory.
103	Internal Fault 2	Cycle power to sensor. If proper operation is not restored, Contact Factory.
104	Internal Fault 3	Cycle power to sensor. If proper operation is not restored, Contact Factory.
105	Lobe Fault 1	<ul style="list-style-type: none"> • Verify Auto Threshold is enabled. • Cycle power to sensor. • If proper operation is not restored, Contact Factory.
106	Lobe Fault 2	<ul style="list-style-type: none"> • Verify Auto Threshold is enabled. • Cycle power to sensor. • If proper operation is not restored, Contact Factory.
107	Delta Fault	Contact Factory to discuss application.
108	Internal Fault 4	Cycle power to sensor. If proper operation is not restored, Contact Factory.
109	Peak Fault	<ul style="list-style-type: none"> • Verify Auto Threshold is enabled. • Cycle power to sensor. • If proper operation is not restored, Contact Factory.
110	Hardware Fault 1	Cycle power to sensor. If proper operation is not restored, Contact Factory.
111	Power Fault	<ul style="list-style-type: none"> • Cycle power to sensor. • Verify Power Supply rating. • Verify wiring. • If proper operation is not restored, Contact Factory.
112	Hardware Fault 2	Cycle power to sensor. If proper operation is not restored, Contact Factory.
113	Hardware Fault 3	Cycle power to sensor. If proper operation is not restored, Contact Factory.
114	Hardware Fault 4	Cycle power to sensor. If proper operation is not restored, Contact Factory.
115	Timing Fault 1	Cycle power to sensor. If proper operation is not restored, Contact Factory.
116	Timing Fault 2	Cycle power to sensor. If proper operation is not restored, Contact Factory.
117	Timing Fault 3	Cycle power to sensor. If proper operation is not restored, Contact Factory.
118	DAC Fault 1	Cycle power to sensor. If proper operation is not restored, Contact Factory.
119	DAC Fault 2	Cycle power to sensor. If proper operation is not restored, Contact Factory.
120	DAC Fault 3	Cycle power to sensor. If proper operation is not restored, Contact Factory.

Fault Code	Description	Corrective Action
121	DAC Fault 4	Cycle power to sensor. If proper operation is not restored, Contact Factory.
122	SPI Fault 1	Cycle power to sensor. If proper operation is not restored, Contact Factory.
123	SPI Fault 2	Cycle power to sensor. If proper operation is not restored, Contact Factory.
124	Setpoint Fault	The analog setpoints are too close. Minimum distance is 150 mm (6 in.) for analog and 290 mm (11.5 in.) for SIL. Adjust programmed setpoints as needed. (Analog only) If proper operation is not restored, Contact Factory.
125	Loop 1 Out of Range	Verify that magnets are positioned within expected measuring range. Adjust programmed setpoints as needed. (Analog only) If proper operation is not restored, Contact Factory.
126	Loop 2 Out of Range	Verify that magnets are positioned within expected measuring range. Adjust programmed setpoints as needed. (Analog only) If proper operation is not restored, Contact Factory.
127	EEPROM Fault 1	Cycle power to sensor. If proper operation is not restored, Contact Factory.
128	EEPROM Fault 2	Cycle power to sensor. If proper operation is not restored, Contact Factory.
129	Flash Failure	Cycle power to sensor. If proper operation is not restored, Contact Factory.
130	Internal Error	Cycle power to sensor. If proper operation is not restored, Contact Factory.

9. DDA Interface

9.1 Data line termination and biasing

Termination and biasing of RS-485 data lines are as follows:

Biasing

Each LP Series transmitter uses a Fail-safe, Slew Rate-Limited RS-458/RS-422 Transceiver. No additional biasing resistors should be present on the connecting devices (PLC, DCS, PC, Converter).

Termination

Each LP Series transmitter uses a Fail-safe, Slew Rate-Limited RS-458/RS-422 Transceiver. No additional termination resistors are necessary in the connecting devices (PLC, DCS, PC, Converter).

9.2 Communication parameters

The 2-wire differential communication interface and all data transmissions must be at half duplex. Only one device (either the master or a single transmitter) can transmit data at any given time. BAUD rate limitations are listed below.

DDA:	4800 BAUD	8, N, 1
(Reference) Monitor:	DDA RTU Variable BAUD Rate	8, E, 1

10. Hardware and software environments

The DDA digital transmitter operates in a networked, intrinsically safe RS-485 DDA software environment. This environment supports up to 8 multi-dropped transmitters on one communication line. The network requires a 4-wire bus to provide both power and communications to each of the transmitters located in the hazardous area. The transmitters are connected in multi-point configuration (see Figure 25).

The RS-485 network operates in a master/slave mode where the master (host computer or similar type network controller) interrogates each slave (DDA transmitter) for a specific type of data. Each slave has a

unique switch programmable hardware address that is issued by the host computer to activate a particular transmitter. In addition, the DDA hardware supports a command decoder that supports up to 128 different commands. The host computer interrogates a transmitter for data by sending an address byte, followed immediately by a command byte. The addressed transmitter will 'wake up', identify itself by transmitting an echo of its own local address followed by the received command, and then perform the requested action. After the requested action has been completed, the data (if any) will be transmitted back to the host computer on the RS-485 network. Refer to Section 'DDA Command decoder examples' on page 43 for more information.

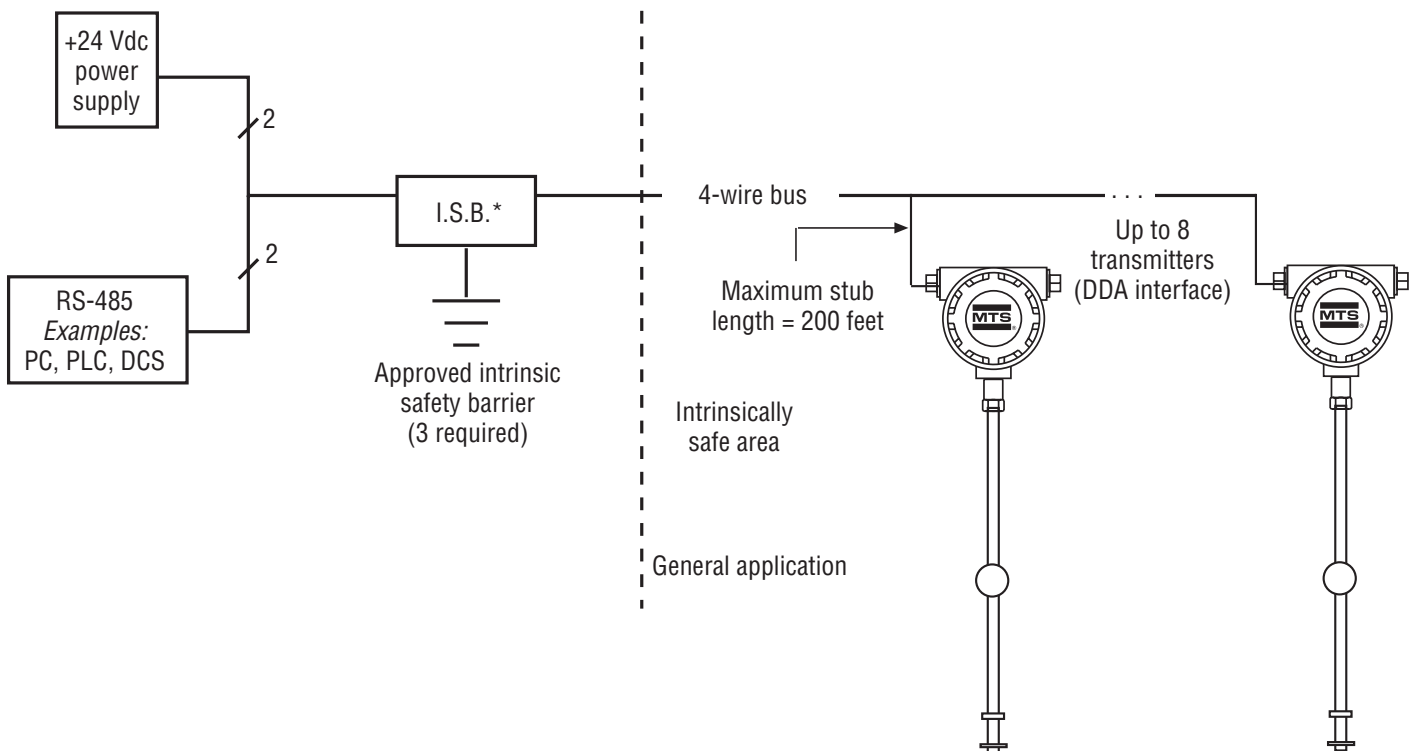
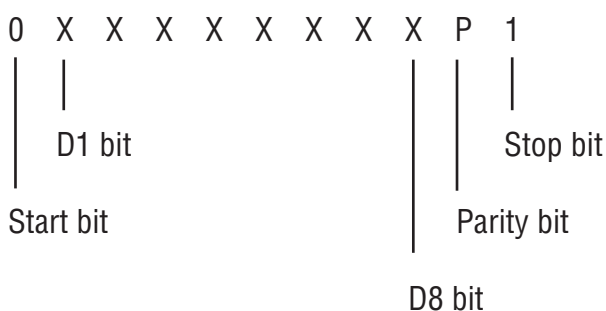

Fig. 2: Typical Electrical Connections - Intrinsically Safe System

11. DDA command decoder examples

11.1 Serial data transmission format

Example 1:



is found, the word is ignored and the decoder circuitry resets for the next transmission. If the parity check is good, the decoder circuitry checks for a valid address byte. The address decoder circuitry uses the 'D8' bit to distinguish the difference between address bytes and command bytes. Address bytes are defined as having the most significant bit 'D8' set equal to one. Valid address byte values include 'C0' hex to 'FD' hex (192 to 253 decimal). Address byte values from 80 hex to 'BF' hex are reserved for future use, address byte values 'FE' and 'FF' hex are reserved for test functions. (see Example 2).

After the DDA address decoder circuitry receives the 11-bit word, an even parity check is performed across the 8-bit data field. If a parity error

11.2 Address byte

Example 2:

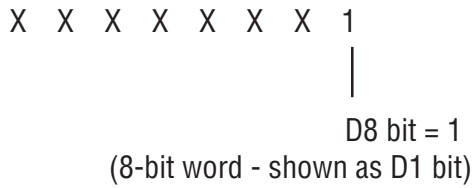

If the received address byte matches the local DDA address, the DDA power supply circuitry is activated. If a valid address byte has been found, the decoder circuitry checks to see if the next received word is a command byte. Valid command byte values include '00' hex to '7F' hex (0 to 127 decimal). In addition, all data byte values are restricted to be within '00' hex and '7F' hex (see Example 3).

11.3 Command byte (and data bytes)

Example 2:

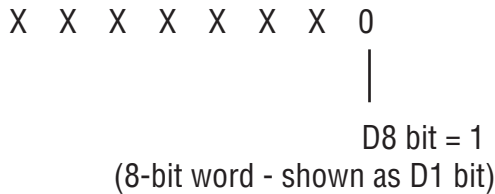

Again, an even parity check is performed on the command byte. If the parity check is good, the eight bit data word is latched into a command buffer. This buffer is read by the DDA software to determine which command to execute. If the parity check fails, the command byte is rejected and the old command (from the previous interrogation sequence) will be left in the command buffer. The DDA hardware cannot determine if the current command was possibly rejected. The host computer must then verify if the correct command was received by reading the echo of the address byte and command byte sent by the DDA transmitter. This is the only guaranteed way to determine that both the address and command bytes were received properly.

This method also insures proper verification, even if the parity check fails to detect a multiple bit data error in either the address byte or command byte. If the host computer determines that either the address byte or command byte has been corrupted, it must wait the proper time-out period and ignore the received message from the DDA transmitter that was improperly interrogated. The time-out period is variable and is based on the duration of the selected DDA command.

12. DDA/Host computer communication protocol

The DDA/Host computer communication protocol consists of two parts: the interrogation sequence generated by the host computer and the data response generated by the interrogated DDA transmitter. The host interrogation sequence always consists of an address byte followed immediately by a command byte (see Example 4).

12.1 DDA/Host communication

Example 4:

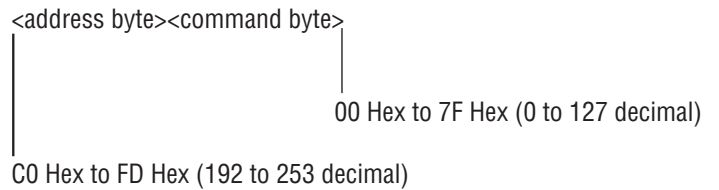

The maximum delay between the address byte and the command byte is 5 milliseconds. The DDA transmitter will not receive the new command byte if this delay period is exceeded (and the old command byte will be left in the command buffer). See previous section for additional information on verification of the Address/Command bytes. An example of an interrogation sequence to access a transmitter programmed for address 'F0' hex (see Example 5).

The transmitter response consists of several components. After a transmitter has been interrogated, the transmitter first responds by transmitting its own local address and the command that was received from the host computer. This re-transmission of the transmitter address and received command serves two purposes. The first being a simple identification that the correct transmitter received the correct command and that it is currently active. The second purpose is to reset the DDA Address/Command decoder circuitry for the next interrogation sequence.

12.2 Interrogation data sequence

Example 5:

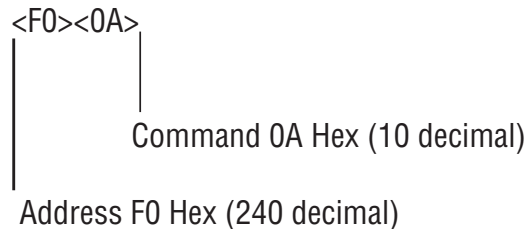

Note:

If the DDA transmitter does not respond to the first interrogation by the host, the Address/Command decoder will be left in an intermediate state. If this occurs, the host will have to reinterrogate the respective transmitter to reset the Address/Command decoder circuitry and then interrogate the respective transmitter again to perform a new transmitter measurement. This hardware feature must be considered when writing software communication drivers to access DDA transmitter data.

After the DDA transmitter has retransmitted its local address and received command, it will perform the requested measurement as defined by the received command. After the requested measurement has been completed, the data for that measurement will be transmitted to the host in a predefined format including certain control characters. The DDA transmitted data format begins with a 'start of text' 'STX' character (STX = 02 hex). The 'STX' character set is immediately followed by the requested data and then terminated with an 'end of text' 'ETX' character set (ETX = 03 hex). Certain commands allow multiple data fields to be transmitted within one transmitted data sequence. For these data transmissions, each data field is separated by an ASCII colon ':' character (: = 3A hex), (see Examples 6 and 7).

Single field data transmission

Example 6:

```
<STX><ddd.ddd><ETX>
```

Multiple field data transmission

Example 7:

```
<STX><ddd.ddd:ddd.ddd:ddd.ddd><ETX>
```

All transmitted data will consist of 7-bit ASCII characters limited to hex values between '00' hex and '7F' hex (i.e. data bit D8 = 0).

After a DDA transmitter has completed a data transmission, the host must wait 50 milliseconds before another interrogation can be performed. This delay is required to enable the previously interrogated transmitter to go into sleep mode and release the network communication lines.

All DDA control commands support a checksum calculation function, Data Error Detection (DED) that allows the host computer (master) to check the integrity of the transmitted data. The actual checksum value that is transmitted is the compliment (2's compliment) of the calculated value. The checksum scheme is based on a 16-bit summation of the hex data within the transmitted block (including 'STX' and 'ETX' character sets) without regard to overflow. The two byte result of the adding process is then complimented and appended to the transmitted data block.

This compliment process makes the final checksum comparison more efficient in that the checksum result added to its compliment will always result in a zero sum for uncorrupted data transmissions. Checksum data (two hex bytes) can range from '0000' hex to 'FFFF' hex. Since the communication network only allows transmitted data values between '00' and '7F' hex, special processing is required on the hex checksum value before it can be transmitted.

This two byte hex value must first be converted to numeric (decimal) ASCII characters before transmission. For example, a checksum value of 'FFFF' hex would be transmitted as ASCII 65535. The host computer would then have to convert ASCII 65535 back to FFFF hex and perform its own checksum calculation and comparison for the received data from the DDA transmitter. An example is shown (see Example 8) of a single field data transmission including checksum data and an sample checksum calculation.

Checksum calculation

Example 8:

```
<STX><ddd.ddd><ETX><cccc>
```

Append checksum value

Note:

The appended checksum value will always consist of five decimal (ASCII) characters ranging from 00000 to 65535. The checksum function can be enabled or disabled.

Message transmitted from DDA transmitter (command 12 Hex):

```
<STX><265.322.109.456><ETX>64760
```

Hex character equivalent of transmitted data record including <STX> and <ETX> characters:

```
02, 32, 36, 35, 2E, 33, 32, 32, 3A, 31, 30, 39, 2E, 34, 35, 36, 03
```

Two byte Hex summation of data: 0308 Hex

Two's compliment: FCF8 Hex

Convert to decimal ASCII: 64760

To verify transmitted data from the DDA transmitter, perform the two byte Hex summation over the data record (including '<STX>' and '<ETX>') shown in (Example 8). The result in this example is 0308 Hex. Then convert the decimal ASCII checksum value back to Hex (for example, 64760 to FCF8 Hex). Add the Hex summation value to the Hex checksum value and the result will be zero (disregarding overflow) for uncorrupted data. 0308 Hex + FCF8 Hex = 0000 Hex.

Note:

Cyclic Redundancy Check (CRC) error checking will be offered at a later date. A command switch will be defined that will let the DDA data be transmitted with CRC error checking instead of checksum error checking. The checksum calculations will use the CRC-CCITT defined polynomial with a 16-bit CRC result. This 16-bit CRC value will be appended to each transmitted message. Since the communication network only allows transmitted data values between 00 and 7F hex, special processing is required on the 16-bit hex CRC value before it can be transmitted. This 16-bit (two byte) hex value must first be converted to numeric (decimal) ASCII characters before transmission. For example, a checksum value of 'FFFF' hex would be transmitted as ASCII 65535.

12.3 Network protocol/timing considerations

The DDA network has several timing constraints that must be considered when designing and coding communication drivers. The DDA network follows the RS-485 standard which defines a multi-drop communication interface that uses differential drivers and receivers operating in half-duplex mode. When using the RS-485 standard configuration, each device's driver and receiver are wired together (see Figure 26).

Each device drive on the network must be disabled (high impedance) except when the device is ready to transmit data. In order to keep devices from transmitting data at the same time, one device is selected as the host (or master). In a DDA network, the host computer (or other communication interface) is the master, and controls the communication timing and protocol. The DDA transmitters act as slave devices, only transmitting data when requested by the host computer device. In this case, the host computer enables its driver and transmits the 'Address/Command' interrogation sequence.

After the Address/Command has been completely transmitted, the host disables its driver to allow reception of the data from the DDA transmitter. The transmitter with the matching address then becomes active, enables its driver and transmits the Address/Command echo followed by the requested data.

The transmitter then disables its driver and goes back into sleep mode. Since all devices operate independently, certain timing constraints are imposed on the protocol to eliminate multiple devices from transmitting data simultaneously.

Network protocol timing sequences (interrogation sequences) are shown in (Figure 27). This time line representation of data transmission sequences also provides information about host computer control of the RS-485 communication card and also illustrates driver enabled control through the RTS control line.

Note:

Many available communication cards (line drivers) for use with the host computer device use a special control line input to control the enabling and disabling of the RS-485 driver. Typically this input is connected to the computers RTS or DTR communication port control line. The computer can then control the state of the driver by toggling the RTS or DTR signal lines via software control. An example of this control method is shown in (Figure 27). Other control methods are also used depending on the manufacturer of the equipment.

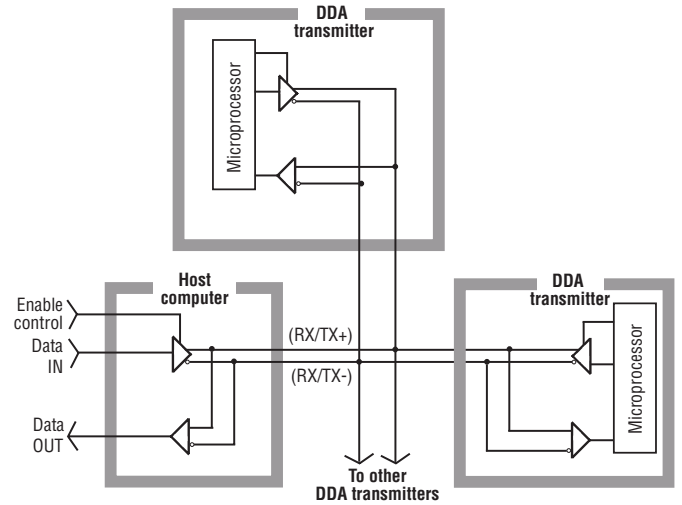

Fig. 3: RS-485 Multi-drop example

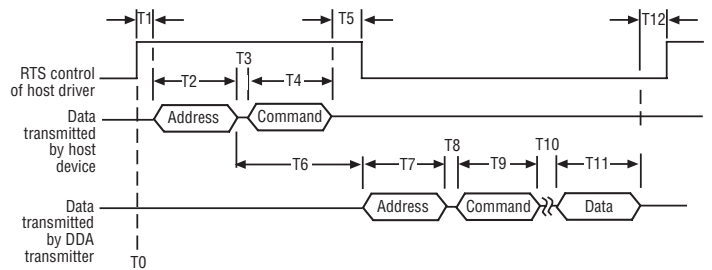

Fig. 4: Network protocol timing information

The following steps provide an interrogation sequence example:

1. The start of the sequence begins when the host enables its RS-485 driver to transmit the Address/Command bytes (see time line 'T0' in Figure 27).
2. After the driver is enabled, the host performs a small time delay 'T1'. In this example, the host enables the driver by raising the RTS control line of the computer to the active (enabled) state. This typically requires no more than 1 millisecond. If the communication lines are extremely long, additional time may be required due to the additional capacitance of the wires.
3. The host then transmits the address byte followed immediately by the command byte. For 4800 Baud transmission rates, the time to transmit one byte (11-bit word size) is fixed at 2.3 milliseconds. Then time delays 'T2' and 'T4' are fixed at 2.3 milliseconds. Time delay 'T3' is the interbyte transmission time. Normally this is at least one bit time (0.21 milliseconds @ 4800 Baud) which is controlled by the computer communication hardware. Sometimes software overhead can extend this delay. The maximum permissible delay for period 'T3' is 5 milliseconds. Then the total maximum delay for periods 'T2, T3, T4' is 9.6 milliseconds.
4. After the host transmits the address and command bytes, the host disables its driver to allow the transmitter to transmit the

Address/Command echo and the requested data. Before the driver is disabled, the software must insure that the command byte has been completely transmitted. This can be done by observing control flags from 'UART' of the communication port, such as Transmit Register Empty (TRE) and Transmit Holding Register Empty (if the UART is double buffered). Software delay methods based on maximum character transmission times for 4800 Baud rates can also be used but are less reliable. Once it has been verified that the command byte '0' has been completely transmitted, an additional delay should be added before the driver is disabled.

This delay 'T5' will insure that data has propagated the network wiring before the driver goes to the high impedance (disabled) state. A delay period of 'T5' = 1 millisecond is adequate for most long cable runs. The maximum delay allowed for 'T5' is based on the fact that time period 'T6' is fixed in the DDA hardware to be 22 (+/-2) milliseconds. The host driver should be disabled well before (at least 5 milliseconds) the DDA transmitter enables its driver and begins transmission of the Address/Command echo. Assuming the maximum delay of 5 milliseconds for period 'T3', and 2.3 milliseconds for 'T4', and that the host driver should be disabled for 5 milliseconds before the transmitter begins transmitting data, the maximum delay for 'T5' then is 7.7 milliseconds.

Note:

If 'T3' is less than 5 milliseconds, then the maximum delay for 'T5' can be extended by the difference (5 milliseconds - T3 actual).

cannot be interrogated until time period 'T12' = 50 milliseconds has elapsed.

9. Repeat the sequence for the next transmitter. Sequences also provide information about host computer control of the RS-485 communication card and also illustrates driver enabled control through the RTS control line.

Other protocol considerations

1. The transmitted ASCII data from the DDA transmitter may contain data fields with 'Exxx' error codes. All DDA error codes are preceded by ASCII 'E' (45 hex, 69 decimal). Communication interface drivers must parse and handle DDA error codes properly or data processing errors could result. For additional information about DDA error codes, (see page 54).
2. Use the DDA 'Data Error Detection' function to verify the integrity of the data transmitted from the transmitter.
3. Certain RS-485 communication cards and (RS-232 to RS-485 converter cards) allow user control of the receiver function. This feature must be considered when developing communication drivers. Due to the half-duplex RS-485 loopback wire connections, all data that is transmitted by the host computer device will be 'echoed' into the receiver inputs. If the receiver function is enabled, then the host transmitted data along with the DDA transmitted data will be received into the computer receive buffer.

5. The transmitter will begin to transmit the Address/Command echo in 22 (+/- 2) milliseconds after the address byte is received from the host computer. This is defined as period 'T6' and is fixed by the DDA hardware. Based on a Baud rate of 4800, the address echo is transmitted in 2.3 milliseconds (period 'T7'). The interbyte delay period 'T8' for the DDA transmitter is fixed at 0.1 milliseconds and the command echo is transmitted 2.3 milliseconds (period 'T9').
6. Period 'T10' is the time required for the DDA electronics to perform the requested command. This is a variable delay based on the command requested. The typical transmitter response time for each command is listed in section '11.4 DDA command definitions'.
7. Period 'T11' is the time required for the DDA electronics to transmit the data for the requested command. This is a variable delay based on the command requested. The typical data transmission time for each command is listed in section '11.4 DDA command definitions'.
8. After the transmitter has completed the data transmission for the requested command, it will disable its driver and go back to inactive mode. The transmitter electronics require 50 milliseconds to transition from active mode to inactive mode. Another transmitter (or the same transmitter)

13. DDA Command definitions

13.1 Special control commands

Command 00 Hex (0 Dec) - Transmitter disable command

This command can be used to disable an active transmitter (force transmitter back to sleep mode). This command does not need to be preceded by an address byte and can only be issued when DDA transmitters are not transmitting data. This 'disabled' command is typically used with other commands that could leave the transmitter in active mode, i.e. certain memory transfer commands, test mode commands, etc.

Note:

During normal mode operation, a DDA transmitter will force itself back into sleep mode if any data is transmitted on the network by any other device. This is a safety feature added to the firmware to avoid data collisions on the network.

Command 01 Hex (1 Dec): Module identification command

Data format: <STX><DDA><ETX><cccc>

- Fixed length record containing 3 ASCII characters '<DDA>'
- Five (5) character checksum appended after '<ETX>' character set

Command 02 Hex (2 Dec): Change address

Data format: <SOH><ddd><EOT>

- Fixed length record with three (3) characters
- The data field is the new address
- The data range is the new address
- The data range is from 192 - 253
- '<SOH>' is ASCII 01 Hex
- '<EOT>' is ASCII 04 Hex
- Default Address is '192'

Command 03 Hex - Command Hex 09 - Not Defined

13.2 Level commands

Command 0A Hex (10 Dec): Output level 1 (product) at 0.1 inch resolution (with checksum)

Data format: <STX><ddd.d><ETX><cccc>

- Variable length record with one (1) to four (4) characters to the left of decimal character
- Fixed at one (1) character to the right of decimal character
- Five (5) character checksum appended after the '<ETX>' character set

Note:

<cccc> Checksum characters are only appended if the Data Error Detection (DED) function is enabled.

Command 0B Hex (11 Dec): Output level 1 (product) at 0.01 inch resolution (with checksum)

Data format: <STX><ddd.dd><ETX><cccc>

- Variable length record with one (1) to four (4) characters to the left

of decimal character

- Fixed at two (2) characters to the right of decimal character
- Five (5) character checksum appended after the '<ETX>' character set

Command 0C Hex (12 Dec): Output level 1 (product) at 0.001 inch resolution (with checksum)

Data format: <STX><ddd.d><ETX><cccc>

- Variable length record with one (1) to four (4) characters to the left of decimal character
- Fixed at three (3) characters to the right of decimal character
- Five (5) character checksum appended after '<ETX>' character set

Data characters can include the following:

- 0 through 9
- (-) minus sign
- (.) decimal point
- (E) ASCII 45 Hex precedes all error codes
- (:) ASCII 3A Hex is used as a data field separator for multiple data

Command 0D Hex (13 Dec): Output level 2 (interface) at 0.1 inch resolution (with checksum)

Data format: Same as Command 0A

Command 0E Hex (14 Dec): Output level 2 (interface) at 0.01 inch resolution (with checksum)

Data format: Same as Command 0B

Command 0F Hex (15 Dec): Output level 2 (interface) at 0.001 inch resolution (with checksum)

Data format: Same as Command 0C

Command 10 Hex (16 Dec): Output level 1 (product) and level 2 interface at 0.1 inch resolution (with checksum)

Data format: <STX><ddd.d:ddd.d><ETX><cccc>

- Variable length record with one (1) to four (4) characters to the left of each decimal character in each data field
- Fixed at one (1) character to the right of each decimal character in each data field
- Level 1, level 2 data fields separated by ASCII colon (:) character
- Five (5) character checksum appended after the '<ETX>' character set

Command 11 Hex (17 Dec): Output level 1 (product) and level 2 interface at 0.01 inch resolution (with checksum)

Data format: <STX><ddd.dd:ddd.dd><ETX><cccc>

- Variable length record with one (1) to four (4) characters to the left of each decimal character in each data field
- Fixed at two (2) characters to the right of each decimal character in each data field.
- Level 1, level 2 data fields separated by ASCII colon (:) character
- Five (5) character checksum appended after the '<ETX>' character set

Command 12 Hex (18 Dec): Output level 1 (product) and level 2 interface at 0.001 inch resolution (with checksum)

Data format: <STX><ddd.d:ddd.d><ETX><c-cccc>

- Variable length record with one (1) to four (4) characters to the left of each decimal character in each data field
- Fixed at three (3) characters to the right of each decimal character in each data field
- Level 1, level 2 data fields separated by ASCII colon (:) character
- Five (5) character checksum appended after the '<ETX>' character set

Command 13 Hex - Command 18 Hex - Not Defined

13.3 Temperature commands

Command 19 Hex (25 Dec): *Average Temperature at 1.0 °F resolution (with checksum)*

Data format: <STX><ddd><ETX><cccc>

- Variable length record with one (1) to four (4) characters
- Five (5) character checksum appended after the '<ETX>' character set

Note:
Average temperature is the average temperature reading from all DTs submerged by approximately 1.5 inches of product.

Command 1A Hex (26 Dec): *Average temperature at 0.2 °F resolution (with checksum)*

Data format: <STX><ddd.d><ETX><cccc>

- Variable length record with one (1) to four (4) characters to the left of decimal character
- Fixed at one (1) character to the right of decimal character
- Five (5) character checksum appended after the '<ETX>' character set

Command 1B Hex (27 Dec): *Average temperature at 0.02 °F resolution (with checksum)*

Data format: <STX><ddd.dd><ETX><cccc>

- Variable length record with one (1) to four (4) characters to the left of decimal character
- Fixed at two (2) characters to the right of decimal character

Five (5) character checksum appended after the '<ETX>' character set

Command 1C Hex (28 Dec):

Individual DT temperature at 1.0 °F resolution (with checksum)

Data format: <STX><ddd:ddd:ddd:ddd><ETX><cccc>

- Variable length record with one (1) to four (4) characters in each data field
- Variable number of data fields (up to 5) separated by ASCII colon (:) characters. Number of data fields is based on the number of DTs programmed in DDA transmitter memory
- First data field is always DT #1, second data field is DT #2, etc
- Five (5) character checksum appended after the '<ETX>' character set

Command 1D Hex (29 Dec):

Individual DT temperature at 0.2 °F resolution (with checksum)

Data format: <STX><ddd.d:ddd.d:ddd.d:ddd.d><ETX><cccc>

- Variable length record with one (1) to four (4) characters to the left

of decimal character in each data field

- Fixed at one (1) character to the right of each decimal character in each data field
- Variable number of data fields (up to 5) separated by ASCII colon (:) characters. Number of data fields is based on the number of DTs programmed in DDA transmitter memory
- First data field is always DT #1, second data field is DT #2,...etc
- Five (5) character checksum appended after the '<ETX>' character set

Command 1E Hex (30 Dec):

Individual DT temperature at 0.02 °F resolution (with checksum)

Data format: <STX><ddd.dd:ddd.dd:ddd.dd:ddd.dd><ETX><c-cccc>

- Variable length record with one (1) to four (4) characters to the left of decimal character in each data field
- Fixed at two (2) characters to the right of each decimal character in each data field
- Variable number of data fields (up to 5) separated by ASCII colon (:) characters. Number of data fields is based on the number of DTs programmed in DDA transmitter memory
- First data field is always DT#1, second data field is DT #2,...etc
- Five (5) character checksum appended after the '<ETX>' character set

Command 1F Hex (31 Dec):

Average and individual DT temperature at 1.0 °F resolution (with checksum)

Data format: <STX><ddd:ddd:ddd:ddd:ddd><ETX><cccc>

- Variable length record with one (1) to four (4) characters in each data field
- Variable number of data fields (up to 6) separated by ASCII colon (:) characters. The number of data fields is based on the number of DTs programmed in DDA transmitter memory (number of DTs + 1)
- The first data field is always the average of the individual DTs submerged by at least 1.5 inches of product
- The second data field is always DT #1, third data field is DT #2, ... etc
- Five (5) character checksum appended after the '<ETX>' character set

13.4 Multiple Output Commands (Level and Temperature)

Command 28 Hex (40 Dec): *Level 1 (product) at 0.1 inch resolution, and average temperature at 1.0 °F resolution (with checksum)*

Data format: <STX><ddd.d:ddd><ETX><cccc>

- Variable length record with one (1) to four (4) characters to the left of decimal character in first data field
- Fixed at one (1) character to the right of decimal character in first data field
- Variable length record with one (1) to four (4) characters in second data field
- Level 1 temperature data fields separated by ASCII colon (:) character
- Five (5) character checksum appended after the '<ETX>' character set

13.4 Multiple Output Commands (*continued*)

Command 29 Hex (41 Dec): *Level 1 (product) at 0.01 inch resolution, and average temperature at 0.2 °F resolution (with checksum)*

Data format: <STX><dddd.dd:dddd.d><ETX><ccccc>

- Variable length record with one (1) to four (4) characters to the left of decimal character in first data field
- Fixed at two (2) characters to the right of decimal character in first data field
- Variable length record with one (1) to four (4) characters to the left of decimal character in second data field
- Fixed at one (1) character to the right of decimal character in second data field
- Level 1, temperature data fields separated by ASCII colon (:) character
- Five (5) character checksum appended after the '<ETX>' character set

Command 2A Hex (42 Dec): *Level 1 (product) at 0.001 inch resolution, and average temperature at 0.02 °F resolution (with checksum)*

Data format: <STX><dddd.ddd:dddd.dd><ETX><ccccc>

- Variable length record with one (1) to four (4) characters to the left of decimal character in first data field
- Fixed at three (3) characters to the right of decimal character in first data field
- Variable length record with one (1) to four (4) characters to the left of decimal character in second data field
- Fixed at two (2) characters to the right of decimal character in second data field
- Level 1, temperature data fields separated by ASCII colon (:) character
- Five (5) character checksum appended after the '<ETX>' character set

Command 2B Hex (43 Dec):

Level 1 (product), level 2 (interface) at 0.1 inch resolution, and average temperature at 1.0 °F resolution (with checksum)

Data format: <STX><dddd.d:dddd.d:dddd><ETX><ccccc>

- Variable length record with one (1) to four (4) characters to the left of decimal character in first data field
- Fixed at one (1) character to the right of decimal character in first data field
- Variable length record with one (1) to four (4) characters to the left of decimal character in second data field
- Fixed at one (1) character to the right of decimal character in second data field
- Variable length record with one (1) to four (4) characters in third data field
- Level 1, level 2, temperature data fields separated by ASCII colon (:) character
- Five (5) character checksum appended after the '<ETX>' character set

Command 2C Hex (44 Dec):

Level 1 (product), level 2 (interface) at 0.01 inch resolution, and average temperature at 0.2 °F resolution (with checksum)

Data format: <STX><dddd.dd:dddd.dd:dddd.d><ETX><ccccc>

- Variable length record with one (1) to four (4) characters to the left of decimal character in first data field
- Fixed at two (2) characters to the right of decimal character in first data field
- Variable length record with one (1) to four (4) characters to the left of decimal character in second data field
- Fixed at two (2) characters to the right of decimal character in second data field
- Variable length record with one (1) to four (4) characters to the left of decimal character in third data field.
- Fixed at one (1) character to the right of decimal character in third data field
- Level 1, level 2, temperature data fields separated by ASCII colon (:) character
- Five (5) character checksum appended after the '<ETX>' character set

Command 2D Hex (45 Dec): *Level 1 (product), level 2 (interface) at 0.001 inch resolution, and average temperature at 0.02 °F resolution (with checksum)*

Data format: <STX><dddd.ddd:dddd.dd:dddd.dd><ETX><ccccc>

- Variable length record with one (1) to four (4) characters to the left of decimal character in first data field
- Fixed at three (3) characters to the right of decimal character in first data field
- Variable length record with one (1) to four (4) characters to the left of decimal character in second data field
- Fixed at three (3) characters to the right of decimal character in second data field
- Variable length record with one (1) to four (4) characters to the left of decimal character in third data field
- Fixed at two (2) characters to the right of the decimal character in third data field
- Level 1, level 2, temperature data fields separated by ASCII colon (:) character
- Five (5) character checksum appended after the '<ETX>' character set

Command 2E Hex - Command 30 Hex - Not Defined

Command 31 Hex - Command 40 Hex - Reserved for factory use

13.5 High-level memory read commands

Command 4B Hex (75 Dec): *Read 'number of floats and number of DTs' control variables*

Data format: <STX><d:d><ETX><ccccc>

- Fixed length record with one (1) character in each field
- The first data field is the number of floats, second data field is the number of DTs
- Five (5) character checksum appended after the '<ETX>' character set

Command 4C Hex (76 Dec): *Read 'gradient' control variable*

Data format: <STX><d:dddd><ETX><ccccc>

- Fixed length record with seven (7) characters (including decimal point)
- Five (5) character checksum appended after the '<ETX>' character set

Command 4D Hex (77 Dec): *Read float zero position data (float #1 and #2)*

Data format: `<STX><dddd.ddd:dddd.ddd><ETX><cccc>`

Command 4D Hex (77 Dec) (continued):

- Variable length record with one (1) to four (4) characters to the left of decimal character in first data field. The data may include an ASCII (-) negative sign character (2D Hex) in the first character position
- Fixed at three (3) characters to the right of decimal character in first data field
- Variable length record with one (1) to four (4) characters to the left of decimal character in second data field. The data may include an ASCII(-) negative sign character (2D Hex) in the first character position
- Fixed at three (3) characters to the right of decimal character in second data field
- Float #1, float #2 data fields separated by ASCII colon (:) character
- Five (5) character checksum appended after the '<ETX>' character set

Command 4E Hex (78 Dec):

Read DT position data (DTs 1 - 5)

Data format:

`<STX><dddd.d:dddd.d:dddd.d:dddd.d:dddd.d><ETX><cccc>`

- Variable length record with one (1) to four (4) characters to the left of decimal character in each data field
- Fixed at one (1) character to the right of decimal character in each data field
- Variable number of data fields (up to 5) separated by ASCII colon (:) characters. The number of data fields is based on the 'number of DTs' control variable. (see command 4B Hex)
- The first data field is always DT #1, second field is always DT #2,... etc.
- Five (5) character checksum appended after the '<ETX>' character set

Note:

DT position data is referenced from the mounting flange of the transmitter housing. DT #1 is the DT closest to the tip of the transmitter.

Command 4F Hex (79 Dec):

Read factory serial number data and software version number

Data format:

`<STX><dddd...dddd:Vd.ddd><ETX><cccc>`

- Fixed length record of 50 characters to the left of the colon character and 6 characters to the right of the colon character (57 total)
- Five character checksum appended after the '<ETX>' character set

Command 50 Hex (80 Dec):

Read firmware control code #1

Data format:

`<STX><d:d:d:d:d><ETX><cccc>`

- Fixed length record with one (1) character in each data field
- First data field is the control variable for the data error detection (DED) mode
- The second data field is the control variable for the communication time-out timer (CTT)
- The third data field is the control variable for temperature data units
- The fourth data field is the control variable for linearization enable/disable

- The fifth data field is the control variable for innage/ullage level output
- The sixth data field is reserved for future use; the output value for this field is ASCII '0'
- See write command (5A Hex) for field value assignments
- Five (5) character checksum appended after the '<ETX>' character set

Command 51 Hex (81 Dec): *Read hardware control code #1*

Data format:

`<STX><dddddd><ETX><cccc>`

- Fixed length record with six (6) characters
- The hardware control code controls various functions in the DDA electronic hardware
- The hardware control code must match the hardware control code stamped on the transmitter label; the control code on the label is preceded by 'CC' (for example, CC001122)
- Five (5) character checksum appended after the '<ETX>' character set
- For additional information about the hardware control code, (see section 5, Quick Start-up Guide Modbus and DDA)

Command 52 Hex (82 Dec): *Not defined*

Command 53 Hex (83 Dec): *Reserved for factory use*

Command 54 Hex (84 Dec): *Not defined*

13.6 High-level memory write commands

Command 55 Hex (85 Dec): *Write 'number of floats and number of DTs'*

control variables

Host Issued Command (Part 1)

Data format:

`<addr><commands>`

- '<addr>' is the DDA transmitter address
- '<command>' is DDA command 55
- After the address and command byte have been transmitted by the host, the respective DDA transmitter will 'wake up' and retransmit (echo) the local DDA address and received command. The DDA transmitter will remain active, waiting for the second part of the memory write command to be issued by the host. If the second part of the memory write command is not received within 1.0 seconds (see note below), or the command is not received in the proper format, the DDA transmitter will cancel the current command sequence and go back to sleep mode.

Note:

The time-out timer function can be enabled or disabled.

Host Issued Command (Part 2)

Data format:

`<SOH><d:d><EOT>`

- Fixed length record with two (2) data fields
- '<SOH>' is ASCII 01 Hex
- The first data field contains the 'number of floats' value to be written to the 'number of floats' control variable. This variable is limited to a value of 1 or 2 (ASCII)
- The second data field contains the 'number of DTs' value to be written to the 'number of DTs' control variable. This variable is limited to a value between 0 and 5 (ASCII)

- ASCII colon (:) is the 'number of floats/number of DTs' field separator
- '<EOT>' is ASCII 04 Hex

DDA Transmitter Response (verification sequence)

Data format: <STX><d:d><ETX><cccc>

- Fixed length record with two (2) data fields
- '<STX>' is ASCII 02 Hex
- The first data field contains the 'number of floats' value to be written to the 'number of floats' control variable. This variable is limited to a value of 1 or 2 (ASCII)
- The second data field contains the 'number of DTs' value to be written to the 'number of DTs' control variable. This variable is limited to a value between 0 and 5 (ASCII)
- ASCII colon (:) is the 'number of floats/number of DTs' field separator
- '<ETX>' is ASCII 03 Hex
- '<cccc>' is a five (5) character checksum appended after the '<ETX>' character set

Host Issued Command (Part 3)

Data format: <ENQ>

- '<ENQ>' is ASCII 05 Hex. This character set is sent by the host to initiate the EEPROM write cycle. After the EEPROM memory locations have been successfully written to, the DDA transmitter will respond back to the host with a 'ACK' character set signifying the memory write cycle was successful, or with a 'NAK' character set signifying the memory write cycle was unsuccessful. See DDA transmitter response below
- EEPROM write time is 10 milliseconds per byte. The 'ACK/NAK' response will not be transmitted by the DDA transmitter until the memory bytes have been written and verified or a memory write error has caused the DDA transmitter to time-out

Note:

EEPROM write time is 10 milliseconds per byte. The ACK/NAK response will not be transmitted by the DDA transmitter until the memory bytes have been written and verified or a memory write error has caused the DDA transmitter to time-out.

DDA Transmitter Response:

Data format: <ACK>

- '<ACK>' is ASCII 06 Hex. This character set is sent by the DDA transmitter to confirm to the host that the EEPROM memory write cycle was completed successfully

Data format: <NAK><Exxx><ETX><cccc>

- '<NAK>' is ASCII 15 Hex. This character set is sent by the DDA transmitter to confirm to the host that the EEPROM memory write cycle was not completed successfully
- '<Exxx>' is an error code defining the memory write error that occurred during the EEPROM write cycle. 'E' is ASCII 45 Hex and 'xxx' is the numeric ASCII error code ranging from 000 to 999. For additional information about DDA error codes, (see section 13.8).
- '<ETX>' is ASCII 03 Hex
- '<cccc>' is a five character checksum appended after the '<ETX>' character set
- Value can range from 00000 to 65535.

All high level memory write commands adhere to the communication sequence as described above,

and consist of the following six components:

1. **Host issued command (Part 1):** <address><command>
2. **DDA transmitter response:** <address><command> echo
3. **Host issued command (Part 2):**
data to be written (including necessary control characters)
4. **DDA transmitter response:** verification sequence
5. **Host issued command (Part 3):** <ENQ>
6. **DDA transmitter response:** <ACK> or <NAK>

Descriptions for other high level memory write commands will include only the Data format for Part 2 of each host issued command.

Command 56 Hex (86 Dec): Write 'gradient' control variable

Data format: <SOH><d.ddddd><EOT>

- Fixed length record with one data field
- '<SOH>' is ASCII 01 Hex
- The fixed length data field contains the 'gradient' value to be written to the 'gradient' control variable. This variable is limited to a value between 7.00000 and 9.99999 (ASCII)
- '<EOT>' is ASCII 04 Hex

Command 57 Hex (87 Dec): Write float zero position data (float #1 or #2)

Data format: <SOH><c:ddd.d><EOT>

- Variable length record with two (2) data fields
- The first data field contains one character that controls which zero position memory location is written to (i.e., float #1 or float #2). This control character is limited to a value of 1 or 2 (ASCII)
- The second data field contains the 'zero position' data value to be written to the 'zero position' memory location. This is a variable length data field with one (1) to four (4) characters to the left of the decimal character and fixed at three (3) characters to the right of the decimal character. The data may include the ASCII (-) negative sign character (2D Hex) in the first position. The zero position data is limited to a value between -999.999 and 9999.999 (ASCII)
- '<EOT>' is ASCII 04 Hex

Note:

Zero position is referenced from the mounting flange of the transmitter housing.

Command 58 Hex (88 Dec): Write float zero position data (float #1 or #2) using DDA calibrate mode.

Data format: <SOH><c:ddd.d><EOT>

- Variable length record with two (2) data fields
- The first data field contains one character that controls which zero position memory location is written to (i.e., float #1 or float #2). This control character is limited to a value of 1 or 2 (ASCII)
- The second data field contains the 'current float position' data value to be used to calculate the 'zero position' value that is to be written to the 'zero position' memory location. This is a variable length data field with one (1) to four (4) characters to the left of the decimal character and fixed at three (3) characters to the right of the decimal character. The data may include the ASCII (-) negative sign character (2D Hex) in the first position. The 'current float position' data is limited to a value between -999.999 and 9999.999 (ASCII)
- '<EOT>' is ASCII 04 Hex

Command 59 Hex (89 Dec): Write DT position data (DT1-5).

Data format: <SOH><c:ddd.d><EOT>

- Variable length record with two (2) data fields

- The first data field contains one (1) character that controls which 'DT position' memory location is written to (i.e. DT position #1, 2, 3, 4 or 5)
- This control character is limited to a value between 1 and 5 (ASCII)
- The second data field contains the 'DT position' data value to be written to the respective 'DT position' memory location. This is a variable length data field with one (1) to four (4) characters to the left of the decimal character and fixed at one (1) character to the right of the decimal character. The DT position data is limited to a value between 0.0 and 9999.9 (ASCII)
- '<EOT>' is ASCII 04 Hex

Command 5A Hex (90 Dec): Write firmware control code #1

Data format: <SOH><d:d:d:d:d><EOT>

- Fixed length record with one character in each data field
- '<SOH>' is ASCII 01 Hex
- The first data field is the control variable for the data error detection (DED) function. This variable can have a value of 0, 1, or 2. A value of 0 enables the DED function, using a 16-bit checksum calculation. A value of 1 enables the DED function, using a 16-bit CRC calculation. A value of 2 disables the DED function
- The second field is the control variable for the communication time-out timer (CTT) function. This variable can have a value of 0 or 1. A value of 0 enables the CTT function, and a value of 1 disables the CTT function
- The third data field is the control variable for temperature data units. This variable can have a value of 0 or 1. A value of 0 enables Fahrenheit temperature units. A value of 1 enables Celsius temperature units
- The fourth data field is the control variable for linearization control. This variable can have a value of 0 or 1. A value of 0 disables linearization of the level data. A value of 1 enables linearization
- The fifth data field is the control variable for innage/ullage level output. This variable can have a value of 0, 1 or 2. A value of 0 enables normal innage level output. A value of 1 enables ullage level output and a value of 2 enables ullage level output with reversed DT submersion processing. Mode 2 is used for inverted transmitter applications where the transmitter is installed from the bottom of the tank
- The sixth data field is reserved for future use. The data value for this field must be '0' (ASCII 30 Hex)
- '<EOT>' is ASCII 04 Hex

Command 5B Hex (91 Dec): Write hardware control code #1

Data format: <SOH><dddddd><EOT>

- Fixed length record with six (6) characters
- '<SOH>' is ASCII 01 Hex
- The hardware control code controls various functions in the DDA electronic hardware
- The hardware control code must match the hardware control code stamped on the transmitter label. The control code on the label is preceded by 'CC' (i.e. CC001122)
- '<EOT>' is ASCII 04 Hex

Command 5C Hex (92 Dec): Not Defined

Command 5D Hex (93 Dec): Reserved for factory use

Command 5F Hex - 7F Hex - Reserved for future use

13.7 Diagnostic/Special command set

enum alarmStatusBits	
INTERFACE_ALARM_HIGH	= 0x0001
INTERFACE_ALARM_LOW	= 0x0002
PRODUCT_ALARM_HIGH	= 0x0004
PRODUCT_ALARM_LOW	= 0x0008
ROOF_ALARM_HIGH	= 0x0010
ROOF_ALARM_LOW	= 0x0020
AVG_TEMP_ALARM_HIGH	= 0x0040
AVG_TEMP_ALARM_LOW	= 0x0080
MAGNET_IS_MISSING	= 0x0100
DIG_TEMP0_ERROR	= 0x0200
DIG_TEMP1_ERROR	= 0x0400
DIG_TEMP2_ERROR	= 0x0800
DIG_TEMP3_ERROR	= 0x1000
DIG_TEMP7_ERROR	= 0x2000
DIG_AVG_TEMP_ERROR	= 0x4000
DELIVERY_IN_PROGRESS	= 0x8000
TRIGGER_LEVEL_ERROR	= 0x10000
EEPROM_ERROR	= 0x20000

13.8 DDA Error codes

All error codes are preceded by a capital letter 'E' ASCII (45 hex) and are in the form of 'Exxx' where 'xxx' can be any number from '000' to '999'. Error codes can be embedded in any data field within a transmitted record. Certain DDA commands can generate multiple error codes. Refer to the following examples:

Command 0A Hex:

<STX><Exxx><ETX><cccc>

Command 2D Hex:

<STX><Exxx:Exxx:ddd.dd><ETX><cccc>

Command 1E Hex:

<STX><E203:dddd.dd:dddd.dd:E207:dddd.dd><ETX><cccc>

E102: Missing Float(s) (Level 1 or Level 2)

The number of floats measured by the hardware is less than the 'number of floats' control variable

E201: No DTs Programmed

A request for temperature data has been made with the 'number of DTs' control variable set to equal zero (0) or all programmed DTs are set inactive (for example, DT position data is set equal to zero (0.000))

E212: DT Communication Error

The indicated DT is not active (for example, DT position data is set equal to zero (0) or is not responding)

14. LP Dashboard, setup software

Adjustments to the calibration and set up parameters of the transmitter can be performed using the LP Series Dashboard package. The software can be run from any PC using a RS-485 to RS-232 converter.

Note:
You must use a RS-485 converter with 'Send Data Control' when using the LP Dashboard to ensure proper operation.
Example: MTS Part Number: 380114

14.1 Installing LP Dashboard

Adjustments to the setup and calibration of the DDA Interface can be performed using the MTS LP Dashboard. The Dashboard can be run from any Windows 7 or newer OS using a RS485 to USB converter (MTS part #380114).

Perform the following steps to install the LP Dashboard and establish communication:

1. Install LP Dashboard from the USB stick that came with the level transmitter or go to <http://www.mtssensors.com> to download the latest version.
2. Connect level transmitter to RS485 to USB converter, connect 24 Vdc power to the level transmitter, and connect the RS485 to USB converter to the PC. Example setup shown below.

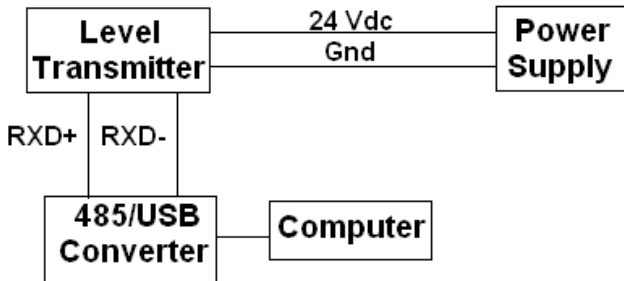

Fig. 5: Example setup

3. Open LP Dashboard and select DDA protocol from drop down menu.
4. Select COM Port. Software will show active COM ports. Make sure converter is connected before starting LP Dashboard or COM port will not show.
5. The default address for the level transmitters from the factory is 192. Select address 192. If you do not know the address you can use the Search function at the bottom of the address range or the display menu.

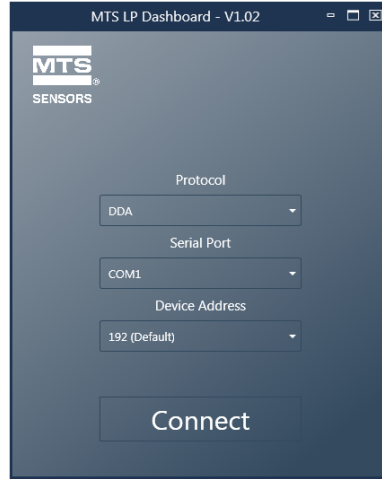

Fig. 6: Initial screen

14.2 Home screen

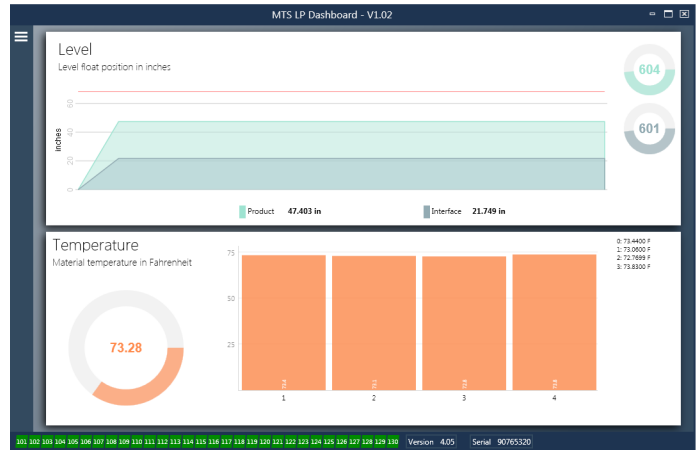

Fig. 7: Home screen

The LP Dashboard Home Screen will look different based on whether or not temperature has been ordered. If the level transmitter includes temperature measurement then the Home Screen will look as shown. If the level transmitter does not include temperature measurement then the Home Screen will not show the bottom panel for temperature. The Home Screen can be accessed by pressing the three white bars on the top left.

The level panel on top shows the level measurement for the Product level and Interface level. If only the product float is selected then only the product float will be shown. The bold numbers are the numerical level and the graph is a time lapse of the graphical representation of the numbers. The red line is the approximate maximum level based off of the order length of the level transmitter. The numbers on the right of the level panel are the Trigger Level for the Product Float on top and the Interface Float on bottom. These are a representation of how strong of a return signal the level transmitter is experiencing.

The temperature panel will only show if temperature measurement was ordered and turned on. The left side shows the numerical value of the average temperature of all temperature sensors below the product level. The bar graph in the middle of the panel shows each individual temperature measurement point. Temperature 1 is always the lowest temperature closest to the bottom of the pipe or hose.

14.2 Home screen (Cont.)

Across the bottom of the Home Screen is the visual indication of the fault codes from section 8. Green indicates no fault and red indicates fault. Next is the firmware version in the middle followed by the serial number.

14.3 Configuration

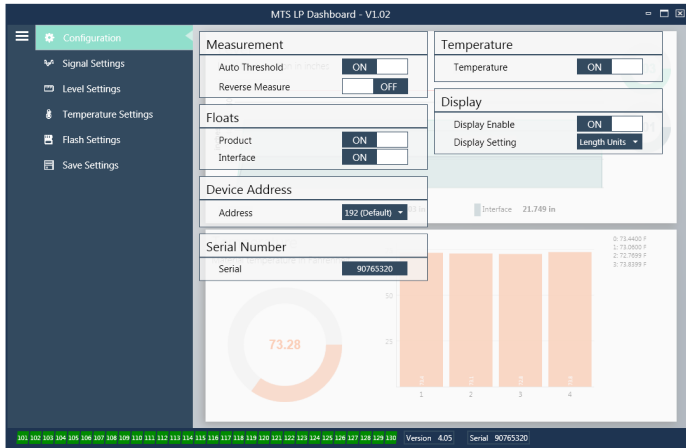

Fig. 8: Configuration

The Configuration tab allows the level transmitter to be configured for the specific application.

Factory Set:

Auto Threshold: Default setting is ON and should not be turned off. This feature allows the unit to automatically adjust the threshold for optimal performance.

Product Float: Default setting of ON for all applications.

Interface Float: Default setting of ON if ordering 2 Loops. Default setting of OFF if ordering 1 Loop. If the number of floats turned on is different from the number of floats physically on the level transmitter the level transmitter will go into Fault.

Serial Number: Serial Number assigned by MTS at the time of manufacture. The serial number is used for tracking and replacement parts. Do not change.

Temperature: Default setting of OFF if ordered without temperature. Default setting of ON if ordered with temperature. Turning temperature ON when the level transmitter was not ordered with temperature will not cause temperature to work and will force the level transmitter into Fault.

Display Enable: Default setting of ON. Display can be turned off by changing to OFF and cycling power.

User Configurable:

Reverse Measure: Allows the end user to change the direction in which the MTS level transmitter counts. The default setting is OFF and the level transmitter will reference the tip of the pipe/hose and count up from the tip. The ON setting will reference the head of the level transmitter and count up as it moves towards the tip.

Device Address: The end user can configure the Modbus address. Default address is 247. The default address should not be used in a network.

14.4 Signal settings

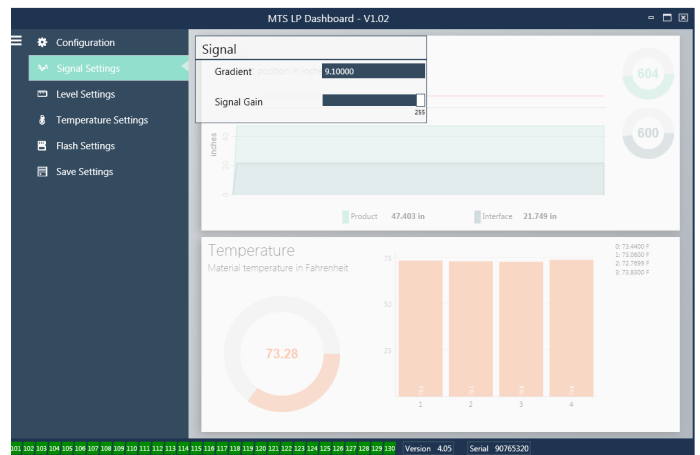

Fig.9: Signal settings

Factory Set:

Gradient: Is the speed at which the magnetostrictive signals travel along the sensing element. Typical range is from 8.9 to 9.2. Do not change unless replacing the sensing element. Changing this number will directly affect accuracy.

Signal Gain: Is the strength of the interrogation pulse. MTS uses the same electronics for all lengths and adjusts the signal based on the order length. Do not change unless instructed to do so by the MTS Factory.

14.5 Level settings

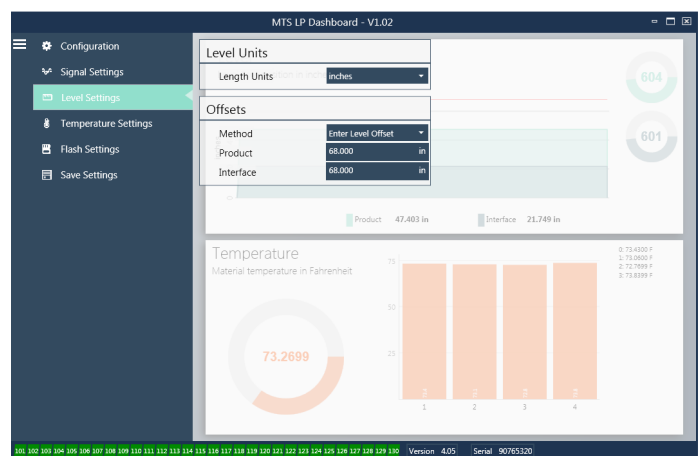

Fig. 10: Level settings

14.5 Level settings (Cont.)

Factory Set:

Method – Enter Level Offset: a calibration method that directly changes the offset of the level measurement. The offset is the zero reference point used in determining the level output. Do not use without Factory guidance.

Product Offset: the full length of the level transmitter including order length, inactive zones, and mounting length. Do not change the Enter Level Offset method without Factory guidance. The offset will change after using the Enter Current Tank Level for the Product. The Product Offset and Interface Offset are independent of one another.

Interface Offset: the full length of the level transmitter including order length, inactive zones, and mounting length. Do not change the Enter Level Offset method without Factory guidance. The offset will change after using the Enter Current Tank Level for the Interface. The Product Offset and Interface Offset are independent of one another.

User Configurable:

Length Units: the unit of measurement used for engineering units. Default is inches if ordered in inches and mm if ordered in mm. Options include inches, feet, millimeters, centimeters, and meters.

Method - Enter Current Tank Level: a calibration method that calibrates the level transmitter based off of one point of measurement. Select Enter Current Tank Level from the Method drop down box. Go to Product Level and enter value of current product level based off of a manual measurement while the tank level is not changing. Go to Interface Level and enter value of current interface level based off of a manual measurement while the tank is not changing. Click Update box in lower left corner when it appears. Level transmitter is now calibrated.

14.6 Temperature settings

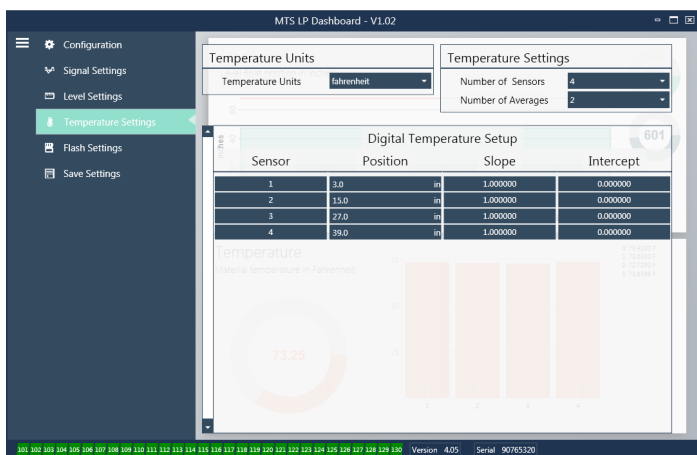

Fig. 11: Temperature settings

Factory Set:

Number of Sensors: Defines how many temperature sensors the level transmitter is looking for. The number should match the number of temperature sensors in the model number.

Number of Averages: This is the number of temperature readings that are averaged together for the temperature output. The higher the number the more temperature readings that are averaged. The higher the number the smoother the output but also the slower the update to changes in the process temperature.

Position: The location of the temperature sensor in reference to the end of the pipe.

Slope: Calibration factor for the temperature sensor. The defaults setting is 1.0. Do not change unless a new sensing element with temperature is ordered.

Intercept: Calibration factor for the temperature sensor. The default setting is 0.0. Do not change unless a new sensing element with temperature is ordered.

User Configurable:

Temperature Units: Change the units of measure for the temperature settings. Options are Fahrenheit or Celsius.

14.7 Flash settings

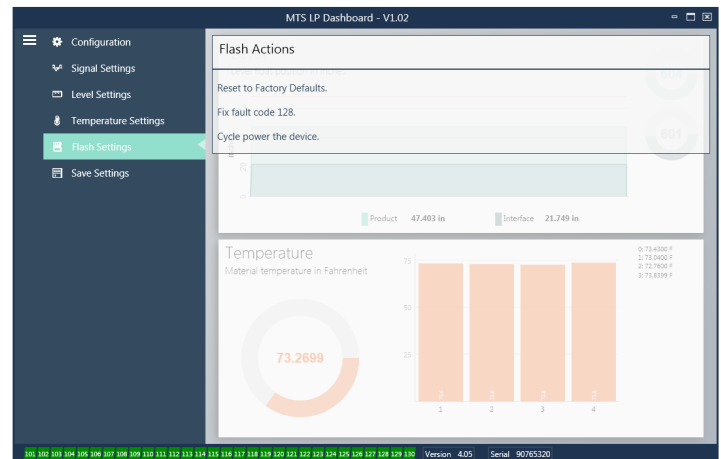

Fig. 12: Flash settings

User Configurable:

Reset to Factory Defaults: Allows the end user to reset all settings back to the original settings as they were when they left the MTS factory. This is intended to be used as a first step in troubleshooting. Do note, the Zero and Span set points will reset to factory settings.

Fix fault code 128: If fault code 128 appears red then click the link on the Dashboard to clear the fault.

Cycle power the device: Allows the end user to have the level transmitter automatically turn power off, turn power on, and reboot the device.

14.8 Save settings

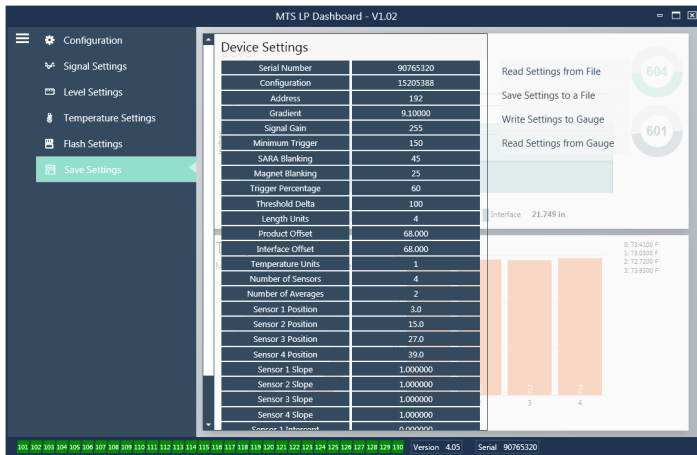

Fig. 13: Save settings

User Configurable:

Read Settings from File: Allows the end user to upload factory parameters from a backup file to the LP Dashboard. This task is usually performed from a saved backup file or the original backup file maintained by MTS.

Write Setting to a File: Allows the end user to download a backup file of factory parameters from the LP Dashboard to a PC. This task is usually performed after Read Settings from Gauge. Note – wait until all settings have changed from Red to White before writing as the color change signals that the settings have been updated.

Write Settings to Gauge: Allows the end user to program the level transmitter with the factory parameters displayed on the LP Dashboard. This task is usually performed after Read Settings from File.

Read Settings from Gauge: Allows the end user to update all of the factory parameters displayed on the screen. All setting will turn Red and then will turn white as they are updated.

Note:

A copy of the backup file is maintained by MTS including all factory parameters as the level transmitter was originally setup after completing testing and calibration at the MTS factory. MTS can provide a copy of the backup file upon request based off of the serial number of the level transmitter. Contact MTS Technical Support for assistance.

14.9 Programming the display

The display diagram is shown in section 6.2. The display menu structure is shown in section 6.3. This section of 9.3 explains the details of the programming available under the different sections of the display. The factory password for entering the display is **27513**.

14.9.1 Data from Device

Display

Allows the user to select if the display shows Length Units.

Units

Allows the user to change the selected Length Units and/or Temperature Units.

Address

Allows the user to change the address of the level transmitter. Default address is 192.

Signal Strength

Allows the user to view the strength of the return signal for the product float (Prod Trig Lvl), interface float (Int Trig Lvl). If the Interface float is not active no signal can be viewed.

14.9.2 Calibrate

Product Level

Allows the user to change the level in engineering units for calibration. The user should use the Current Level selection and enter the current position of the float. The user is advised not to use the Offset feature without help from Technical Support.

Interface Level

Allows the user to change the level in engineering units for calibration. The user should use the Current Level selection and enter the current position of the float. The user is advised not to use the Offset feature without help from Technical Support.

14.9.3 Factory

Settings

Menu section that contains factory parameters. Do not edit these parameters without talking to Technical Support.

Gradient

The gradient is a calibration factor that is unique for each transmitter. Typical values are between 8.9 and 9.2 $\mu\text{s/in}$.

Serial Number

The Serial Number is the unique identifier for the unit from MTS and should not be changed. The serial number is used for tracking and determining spare parts.

SARA Blanking

Initial blanking distance from the head of the level transmitter. Do not change.

Magnet Blanking

Blanking distance between two floats. Do not change.

14.9.3 Factory (Cont.)

Gain

Measurement of how large an interrogation signal is used. Do not change without Technical Support.

Min Trig Level

Threshold level for return signal to qualify as a valid signal and not noise.

Temp Setup

Allows the user to turn the temperature measurement on or off. Turning it on will not cause the temperature to work if no temperature measurement was ordered.

No. of Temp

Change the number of temperature points the level transmitter is looking for. Changing this number does not change the number of temperature measurement points that were ordered or whether or not temperature measurement was ordered.

Float Config

Allows the user to enable or disable the product float and interface float. The first float measured by the electronics will be used as the product float. If the interface float is turned on and there is no second float both loops will go into alarm.

Auto Threshold

Do not disable.

Reset to Factory

Allows the user to reset the electronics to the original factory settings. This should be used to return the electronics to a known good state when troubleshooting.

Document Part Number:
551700 Revision B (EN) 07/2017

LOCATIONS

USA
MTS Systems Corporation
Sensors Division
3001 Sheldon Drive
Cary, N.C. 27513, USA
Tel. +1 919 677-0100
Fax +1 919 677-0200
info.us@mtssensors.com
www.mtssensors.com

JAPAN
MTS Sensors Technology Corp.
737 Aihara-machi,
Machida-shi,
Tokyo 194-0211, Japan
Tel. +81 42 775-3838
Fax +81 42 775-5512
info.jp@mtssensors.com
www.mtssensors.com

FRANCE
MTS Systems SAS
Zone EUROPARC Bâtiment EXA 16
16/18, rue Eugène Dupuis
94046 Creteil, France
Tel. +33 1 58 4390-28
Fax +33 1 58 4390-03
info.fr@mtssensors.com
www.mtssensors.com

GERMANY
MTS Sensor Technologie
GmbH & Co. KG
Auf dem Schüffel 9
58513 Lüdenscheid, Germany
Tel. +49 2351 9587-0
Fax +49 2351 56491
info.de@mtssensors.com
www.mtssensors.com

CHINA
MTS Sensors
Room 504, Huajing Commercial Center,
No. 188, North Qinzhou Road
200233 Shanghai, China
Tel. +86 21 6485 5800
Fax +86 21 6495 6329
info.cn@mtssensors.com
www.mtssensors.com

ITALY
MTS Systems Srl.
Sensor Division
Via Camillo Golgi, 5/7
25064 Gussago (BS), Italy
Tel. +39 030 988 3819
Fax +39 030 982 3359
info.it@mtssensors.com
www.mtssensors.com

LEGAL NOTICES

MTS, Temposonics and Level Plus are registered trademarks of MTS Systems Corporation in the United States; MTS SENSORS and the MTS SENSORS logo are trademarks of MTS Systems Corporation within the United States. These trademarks may be protected in other countries. All other trademarks are the property of their respective owners.

Copyright © 2017 MTS Systems Corporation. No license of any intellectual property rights is granted. MTS reserves the right to change the information within this document, change product designs, or withdraw products from availability for purchase without notice. Typographic and graphics errors or omissions are unintentional and subject to correction. Visit www.mtssensors.com for the latest product information.

ISO 9001
CERTIFIED

