

# Level Plus<sup>®</sup>

Magnetostrictive Liquid-Level Transmitters  
with Temposonics<sup>®</sup> Technology

## OPERATION AND INSTALLATION MANUAL

M-Series Model USTD II Digital Transmitter





## UNITED STATES

---

### GENERAL:

Tel: +1-919-677-0100  
Fax: +1-919-677-2343  
E-mail: [info.us@mtssensors.com](mailto:info.us@mtssensors.com)  
<http://www.mtssensors.com>

### MAILING AND SHIPPING ADDRESS:

MTS Systems Corporation  
Sensors Division  
3001 Sheldon Drive  
Cary, North Carolina, 27513, USA

### CUSTOMER SERVICE:

Tel: +1-800-457-6620  
Fax: +1-800-498-4442  
E-mail: [orders@mts.com](mailto:orders@mts.com)

### TECHNICAL SUPPORT AND APPLICATIONS:

24 Hour Emergency Technical Support  
Tel: +1-800-633-7609  
e-mail: [levelplus@mts.com](mailto:levelplus@mts.com)

### OFFICE HOURS (EST):

Monday - Thursday: 8:00 a.m. to 5:00 p.m.  
Friday: 8:00 a.m. to 4:00 p.m.

### REMITTANCE ADDRESS:

MTS Systems Corporation  
Sensors Division  
NW 5872  
P.O. Box 1450  
Minneapolis, MN, 55486-5872

### QUOTE AND CONTRACT TERMS & CONDITIONS:

The parties expressly agree that the purchase and use of Material and/or Services from MTS Sensors Division are subject to MTS' Terms and Conditions, in effect as of the date of this document, which are located at [http://www.mtssensors.com/fileadmin/media/pdfs/Terms\\_and\\_Conditions.pdf](http://www.mtssensors.com/fileadmin/media/pdfs/Terms_and_Conditions.pdf) and are incorporated by reference into this and any ensuing contract. Printed Terms and Conditions can be provided upon request by emailing [sensorsinfo@mts.com](mailto:sensorsinfo@mts.com) or if you prefer, go to <http://www.mtssensors.com/index> and click the Quote/Contract Terms and Conditions link at the bottom of the page to download the PDF.

## GERMANY

---

### GENERAL:

Tel.: +49-2351-9587-0  
Fax: +49-2351-56491  
e-mail: [info.de@mtssensors.com](mailto:info.de@mtssensors.com)  
<http://www.mtssensors.com>

### MAILING AND SHIPPING ADDRESS:

MTS Sensor Technologie, GmbH & Co. KG  
Auf dem Schüffel 9  
D - 58513 Lüdenscheid, Germany

### TECHNICAL SUPPORT AND APPLICATIONS:

Tel.: +49-2351-9587-0  
e-mail: [info.de@mtssensors.com](mailto:info.de@mtssensors.com)  
<http://www.mtssensors.com>

## JAPAN

---

### GENERAL:

Tel.: +81-42-775-3838  
Fax: +81-42-775-5516  
e-mail: [info.jp@mtssensors.com](mailto:info.jp@mtssensors.com)  
<http://www.mtssensors.com>

### MAILING AND SHIPPING ADDRESS:

MTS Sensors Technology Corporation  
737 Aihara-cho, Machida-shi  
Tokyo 194-0211, Japan

### TECHNICAL SUPPORT AND APPLICATIONS:

Tel.: +81-42-775-3838  
Fax: +81-42-775-5512

## Model USTD II Operation and Installation Manual

### Reference Information

#### Notices used in this manual

---

This manual contains notices to highlight specific information as follows:

**Notes:**

These notices provide important tips, guidance, or advice.

**Important:**

These notices provide information that might help you avoid inconvenient or problem situations.

**Attention:**

These notices indicate possible damage to programs, devices, or data and is placed just before the instruction or situation in which damage could occur.

**Caution:**

These notices indicate situations that can be potentially hazardous to you. A Caution notice is placed just before a description of a potentially hazardous procedure, step, or situation.

#### Related publications

---

The following publications are listed below by part number followed by description and are available in Adobe Acrobat Portable Document Format (PDF) at <http://www.mtssensors.com/>

550949 - Product Specification, Level Plus USTD II

551103 - Level Plus Accessories Catalog

For information about safe work procedures, refer to the following documentation:

National Electric Code ANSI/NFPA 70

CSA C22.1 Canadian Electrical Code

#### How this manual is organized

---

“Introduction”, provides an overview of the manual.

“Terms and Definitions”, provides definitions of terms used in this manual.

“Product Overview”, gives an overall product description for the Level Plus liquid-level transmitter, its specifications, use, output, and electronics.

“Installation and Mounting”, provides detailed installation and mounting information.

“Electrical Connections and Wiring Procedures”, provides engineering specifications and wiring diagrams to assist in the installation process.

“Maintenance and Field Service”, provides guidelines for general maintenance and procedures for replacing the Model USTD II level transmitter.

“Troubleshooting”, provides a list of symptoms, their possible cause and the action to be taken when troubleshooting the transmitter.

“Quick Start-Up Guide”, provides a list of steps to quickly set up your USTD II.

“DDA Protocol”, provides the DDA hardware and software environment overviews.

“Agency Information” provides comprehensive listings of agency approvals and standards, installation drawings, labels and applicable protocols.

#### Getting information, help, and service

---

You can get the latest ordering information and software updates by visiting [www.mtssensors.com](http://www.mtssensors.com) website

General contact information, shipping and office hours are available on page i.

## Contact information

General .....	i
Mailing and shipping address .....	i
Customer service .....	i
Technical support and applications .....	i
Office hours .....	i
Remittance address .....	i
Quote and contract terms and conditions .....	i

## Reference information

Notices used in this manual .....	ii
Related publications .....	ii
How this manual is organized .....	ii
Getting information, help, and service .....	ii

## Introduction

Introduction .....	1
Public website support portal .....	1

## Terms and Definitions

Terms and definitions reference .....	2
---------------------------------------	---

## Product overview

Product overview .....	3
Industries .....	3
Applications .....	3
Features .....	3
Components .....	3
Housings .....	3
Outer pipe configurations .....	4
Floats .....	5
Internal electronics .....	5
Accessories .....	5
Theory of operation .....	5
Accuracy .....	5
Warranty .....	5
Model number identification .....	6
Product specifications .....	7

## Installation and mounting

Installation and mounting .....	8
Storage .....	8
Installation .....	8
Mounting .....	9
External mounting .....	9
Internal mounting .....	10

## Electrical connections and wiring

Electrical connections and wiring procedures .....	11
Safety recommendations for installation .....	11
Industrial topologies .....	11
Point-to-point .....	11
Bus with spurs .....	11
Tree .....	11
Daisy chain .....	11
Recommended cable types .....	11
Grounding .....	12
Safety barriers .....	12

## Maintenance and field service

General maintenance and field service requirements .....	13
Float maintenance .....	13
Field service .....	13
Service / RMA policy .....	13

## Troubleshooting

Troubleshooting procedures .....	14
----------------------------------	----

## Quick start-up guide

Quick start-up guide .....	14
Before you begin .....	14
Quick start-up procedure .....	14

## DDA user interface

Communication protocol .....	15
Command timing .....	15
Command 02 .....	15
USTD II Command Set .....	16
USTD II error codes .....	17
Digital setup software installation, setup and calibration .....	18
Data from device tab .....	18

## Agency Information

Agency approvals .....	20
FM .....	20
ATEX .....	20
NEPSI .....	20
Hazardous area installation .....	21
FM .....	21
Installation drawings .....	21
Notes .....	22
Wiring connections .....	22
Labels .....	23
ATEX .....	24
Installation drawings .....	24
Notes .....	25
Wiring connections .....	25
Labels .....	26
NEPSI .....	27
Installation drawing .....	27
Notes .....	28
Wiring connections .....	28
Labels .....	29
FM certificate .....	30
ATEX certificate .....	34
NEPSI certificates .....	37

## Model USTD II Operation and Installation Manual

### Introduction

### Introduction

---

MTS is recognized as the pioneer, innovator and leader in magnetostrictive sensing. The new Level Plus® M-Series transmitter design represents a continuation of our on-going effort to provide effective, innovative and reliable products to the Liquid Level marketplace.

This manual will provide the following information about the Level Plus Model USTD II digital transmitter:

- Terms and definitions
- Product overview
- Installation and mounting
- Electrical connections and wiring procedures
- Maintenance and field service
- Troubleshooting
- Quick start-up guide
- DDA interface
- Product certification

### Public website support portal

---

Visit our support portal at <http://www.mtssensors.com> for:

- Building Level Plus M-Series model numbers
- Latest documentation releases
- Detailed ordering information
- Latest software updates

## Terms and definitions reference

---

### D

---

**DDA** – ‘Direct Digital Access’ – The proprietary digital protocol developed by MTS for use in intrinsically safe areas.

### I

---

**Interface** – *Noun*; The measurement of the level of one liquid when that liquid is below another liquid.

**Interface** – *Adj.*; The *Software Graphical User Interface (GUI)* that allows the user to access software protocols (*DDA, MODBUS*).

**Intrinsic safety** – ‘Intrinsically safe’ - Type of protection based on the restriction of electrical energy within apparatus of interconnecting wiring exposed to potentially explosive atmosphere to a level below that which can cause ignition by either sparking or heating effects.

### N

---

**NEMA Type 4X** – A product *Enclosure* intended for indoor or outdoor use primarily to provide a degree of protection against corrosion, windblown dust and rain, splashing water, and hose-directed water; and to be undamaged by the formation of ice on the enclosure. They are not intended to provide protection against conditions such as internal condensation or internal icing.

**NPT** – *U.S. standard* defining tapered pipe threads used to join pipes and fittings.

### S

---

**Specific Gravity** – The *density ratio* of a liquid to the density of water at the same conditions.

## Model USTD II Operation and Installation Manual

### Product Overview

#### Product overview

The Level Plus Model USTD II Liquid-Level transmitter is a continuous multi-functional magnetostrictive transmitter that provides product level, interface level, and temperature to the user via DDA output. Magnetostrictive technology is one of the most accurate and repeatable level technologies available to date. MTS is the inventor and purveyor of magnetostrictive technology and has been serving the level industry for over 30 years.

#### INDUSTRIES

- Petroleum
- Liquid petroleum gas
- Chemical
- Wastewater

#### APPLICATIONS

- Underground storage tanks
- Fuels and Solvents
- Sump

#### FEATURES

- 3-in-1 measurement
  - Product level
  - Interface level
  - Temperature level
- No scheduled maintenance or recalibration
- Non-linearity  $\pm 1$  mm
- Intrinsically Safe

#### Components

The Level Plus Model USTD II liquid level transmitter consists of four main components; a housing, outer pipe, float, and electronics.

#### HOUSING

Level Plus Model USTD II transmitters are available with a NEMA Type 4X 316L stainless steel, housing as shown below:



#### Housing dimension reference

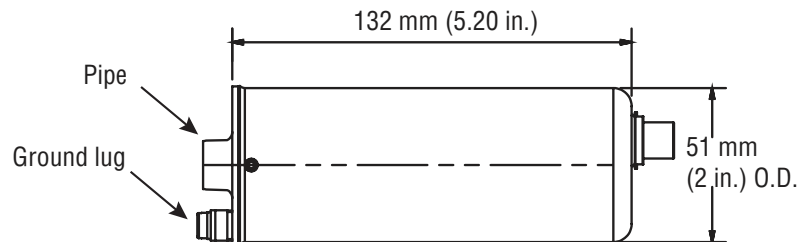

NEMA Type 4X 316L stainless-steel housing



## OUTER PIPE CONFIGURATIONS

The outer pipe is constructed as shown below.

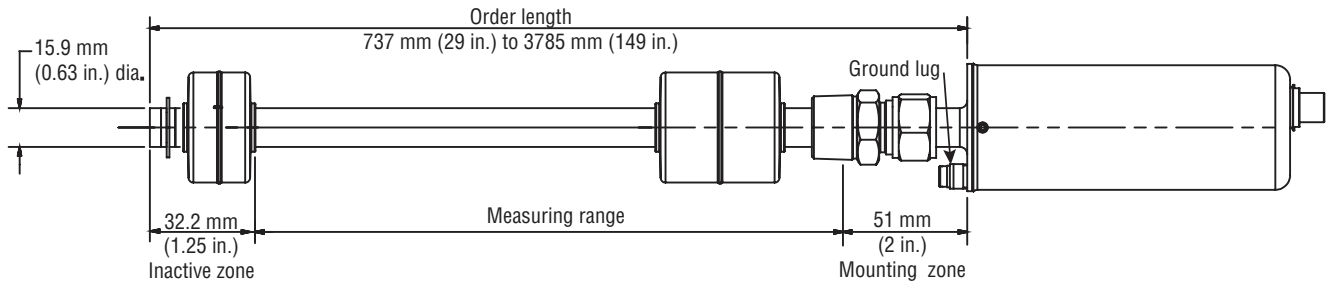

**Figure 1** 5/8 in. diameter rigid outer pipe of 316L stainless steel

## Model USTD II Operation and Installation Manual

### Product Overview

#### FLOATS

Level Plus Model USTD II transmitters offer numerous floats for different applications such as stainless steel, 3-A sanitary, Hastelloy, Teflon, and Nitrophyl for both product level and interface level. To be able to accurately detect the interface level there needs to be a difference of at least 0.05 in specific gravities between the product and interface liquids. For detailed information about floats, refer to the 'Accessories Catalog', MTS part number 551103.

#### INTERNAL ELECTRONICS

All transmitters come with two electronic components of a sensing element and a board set. All sensing elements are rigid. The board set consists of a top board and bottom board. A temperature sensing function is standard with the Model USTD II transmitter. The temperature sensing device is a digital thermometer (DT) mounted inside the transmitter's pipe assembly.

#### ACCESSORIES

MTS also offers a series of displays, housings, converters, and other accessories, please refer to the 'Accessories Catalog', MTS part number 551103.

### Theory of operation

Magnetostrictive M-Series transmitters precisely sense the position of an external float by applying an interrogation pulse to a waveguide medium. This current pulse causes a magnetic field to instantly surround the waveguide. The magnet installed within the float also creates a magnetic field. Where the magnetic fields from the waveguide and float intersect, a rotational force is created (waveguide twist). This, in turn, creates a torsional-sonic pulse that travels along the waveguide as shown in *Figure 2*.

The head of the transmitter houses the sensing circuit, which detects the torsional-sonic pulse and converts it to an electrical pulse. The distance from a reference point to the float is determined by measuring the time interval between the initiating current pulse and the return pulse and precisely knowing the speed of these pulses. The time interval is converted into a level measurement.

For assistance with selecting a specific float for your application, please contact *Technical Support* with the following information:

- Specific gravity of liquid(s) being measured
- Process temperature
- Process Opening Size
- Vessel pressure

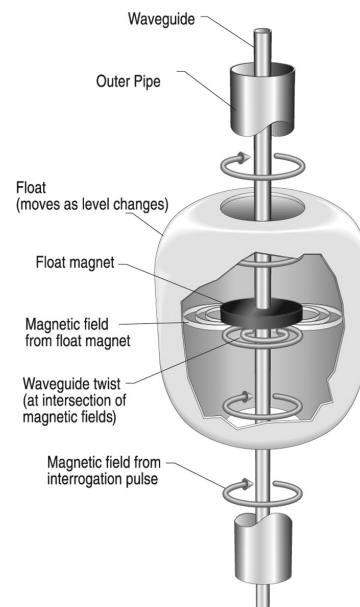

**Figure 2** Theory of operation

#### Accuracy

For magnetostrictive transmitters inherent accuracy is measured in terms of non-linearity. Non-linearity is a measurement of any imperfections in the waveguide that are reflected in the linearity of the transmitter's output. MTS tolerances reflect a maximum non-

linearity of  $\pm 0.5$  mm. MTS is able to achieve such strict tolerances by manufacturing all of its own waveguide from a proprietary alloy and testing 100% of all transmitters before shipping.

#### Warranty

##### Important:

Contact Technical Support or Customer Service for assistance if you suspect that the transmitter is not working correctly. Technical support can assist you with troubleshooting, part replacement, and *Returned Material Authorization* (RMA) information if required.

All M-Series transmitters come with a two year limited warranty from the factory shipment date. A *Return Materials Authorization* (RMA) number is required and must accompany any transmitter returns. Any unit that was used in a process must be properly cleaned in accordance with OSHA standards, before it is returned to the factory. A *Material Safety Data Sheet* (MSDS) must also accompany the transmitter that was used in any process.

## Model number identification for ATEX approval

<b>TRANSMITTER MODEL</b>		=	<b>U</b> <b>S</b> <b>T</b> <b>D</b> <b>I</b> <b>I</b>	1 - 6
M-Series Model USTD II liquid-level transmitter				
<b>UNIT OF MEASURE</b>		=	<input type="text"/>	7
<b>M</b>	= Metric (millimeters)			
<b>U</b>	= US Customary (inches)			
<b>TRANSMITTER ORDER LENGTH</b>		=	<input type="text"/> <input type="text"/> <input type="text"/> <input type="text"/>	8 - 11
<b>Length</b>	<b>Code</b>			
Millimeters	= XXXX (737 mm to 3785 mm)			
Inches	= OXXX (29 in. to 149 in.)			
<b>MOUNTING AND CATEGORY OF APPARATUS</b>		=	<input type="text"/>	12
<b>H</b>	= Fill tube mounting (hanger with centering spacers) FM Approved			
<b>A</b>	= Flange mounting (3/4 in. MNPT adjustable fitting) FM Approved			
<b>6</b>	= Flange mounting (3/4 in. MNPT adjustable fitting) ATEX Approved			
<b>MOUNTING TYPE</b>		=	<input type="text"/>	13
<b>S</b>	= Standard product without cable (FM Approved)			
<b>9</b>	= Standard product without cable (ATEX Approved)			
<b>7</b>	= Cable gland and integral blue cable (ATEX Approved)			

### STANDARD FEATURES

Five DT's, evenly spaced  
Data output format (USTD type)

### USTD II CABLE ASSEMBLY OPTION

Description	Part number
5 m straight connector cable (ATEX)	402486
2 m straight connector cable (FM)	530049
2 m 90° connector cable (FM)	370481

Product specifications

Parameters	Specifications
<b>LEVEL OUTPUT</b>	
<b>Measured variable:</b>	Product level and interface level
<b>Output signal / Protocol:</b>	DDA/USTD
<b>Order length:</b>	<b>Rigid pipe:</b> 737 mm (29 in.) to 3785 mm (149 in.) §△ § Order length equals the distance from the bottom of the housing to the tip of the pipe, (including the inactive zone). △ Contact factory for longer lengths.
<b>Non-linearity:</b>	± 0.5 mm (0.02 in.)
<b>Repeatability:</b>	0.001% F.S. or 0.381 mm (0.015 in.)◇ ◇ Whichever is greater.
<b>TEMPERATURE OUTPUT</b>	
<b>Measured variable:</b>	Average and multipoint temperatures Up to 5
<b>Accuracy:</b>	± 0.28 °C (± 0.5 °F)
<b>ELECTRONICS</b>	
<b>Input voltage:</b>	10.5 to 30.1 Vdc 28 Vdc maximum for I.S. ATEX approval
<b>Fail safe:</b>	High, Full scale
<b>Reverse polarity protection:</b>	Series diode
<b>Lightning/Transient protection:</b>	<b>Stage 1:</b> Line-to-ground surge suppression; IEC 61000-4-5 <b>Stage 2:</b> Line-to-line and line-to-ground transient suppressors; IEC 61000-4-4
<b>CALIBRATION</b>	
<b>Zero adjust range:</b>	Anywhere within the active length
<b>Span adjust range:</b>	Full scale to 152 mm (6 in.) from zero

Parameters	Specifications
<b>ENVIRONMENTAL</b>	
<b>Enclosure rating:</b>	IP 68
<b>Humidity:</b>	0 to 100% relative humidity, noncondensing
<b>Operating temperatures:</b>	<b>Electronics*:</b> -40 °C (-40 °F) to 71 °C (160 °F) <b>Sensing element:</b> -40 °C (-40 °F) to 125 °C (257 °F) <b>Temperature element:</b> -40 °C (-40 °F) to 105 °C (221 °F) * Consult Agency Approvals section for approval specific ambient temperature rating.
<b>Vessel pressure:</b>	4 bar (60 psi)
<b>Materials:</b>	<b>Wetted parts:</b> 316L stainless steel <b>Non wetted parts:</b> 316L stainless steel
<b>FIELD INSTALLATION</b>	
<b>Housing dimensions:</b>	51 mm (2 in.) dia. by 132 mm (5.2 in.) height
<b>Mounting:</b>	¾ in. Adjustable NPT fitting (ATEX, FM) or Fill tube hanger (FM only)
<b>Wiring:</b>	4-wire, plus earth ground
<b>Electrical Connections:</b>	5-pin M12 connector

## Installation and mounting

This section contains information about storing your transmitter (prior to installation) and detailed procedures for installing and mounting your transmitter.

### Storage

If storage is required prior to installation, store indoors in a dry environment at ambient temperature range not exceeding -40 °C (-40 °F) to 71 °C (160 °F).

### Installation

The installation procedures below are illustrated using the adjustable NPT fitting for a external mount. The procedures will have to be slightly adjusted if using a internal mount.

#### RIGID PROBE

##### Tools Required:

- Channel lock pliers
- Common screwdriver

##### Caution:

It is recommended that assembly and mounting of this transmitter should not be performed alone. To ensure proper and safe assembly of the M-Series transmitter, a minimum of two (2) individuals are recommended. Gloves are also recommended. In addition , PPE is required for work areas such as safety shoes, safety glasses, hard hat, and fire resistant clothing.

Perform the following steps to Install the Model USTD II Digital transmitter:

1. Remove the E-ring. With assistance, feed the rigid pipe through the hole of the removed tank flange until the flange is positioned near the top of the transmitter. Insert the threaded portion of the adjustable fitting into the customer supplied flange and tighten (apply pipe thread sealant if required). Be careful not to drop the flange as it can damage the transmitter.
2. Slide the product float onto the rigid pipe. Slide the interface float onto the rigid pipe. Do not drop the float(s) or allow them to free fall along the rigid pipe as damage may result. Install E-ring.
3. Slide floats back down to the E-ring to prevent them from free falling during installation into the tank. Insert the rigid pipe (with floats) through the tank opening and lower the transmitter/float assembly into the tank until it rests on the bottom. **DO NOT DROP OR DAMAGE THE PIPE.**
4. Secure the flange onto the tank mount.
5. Pull the transmitter upward so the end plug is just resting on the floor of the tank. Tighten the adjustable fitting to hold the transmitter in place.
6. Connect wire and cable accordingly.

### Mounting

The method of mounting a Level Plus M-Series transmitter is dependent on the vessel or tank in which it is being used and what type of transmitter is being used. There are two typical methods for mounting, external and internal.

#### EXTERNAL MOUNT

MTS offers the Level Plus Model USTD II transmitter configured with a rigid pipe constructed of 316L stainless steel. The rigid pipe configuration can be ordered in lengths from 737 mm (29 in.) to 3785 mm (149 in.). The Model USTD II can be installed using a flange mount (see illustration below). The flange mount allows the transmitter to be installed external to the tank through a flange with a 3/4 in. MNPT Adjustable fitting which is FM and ATEX approved. The NPT fitting allows the transmitter mount to be adjusted (within an inch) if the tank height and order length are not exactly equal.

The 'Measuring range' of the Model USTD II transmitter is equal to the 'Order length' minus the 'Mounting zone' at 51 mm (2.0 in.) and the 'Inactive zone' of 32 mm (1.25 in.). The Model USTD II transmitter can be ordered with a single product float or can include the optional interface float. Average and individual temperature measurement from five positions are included.

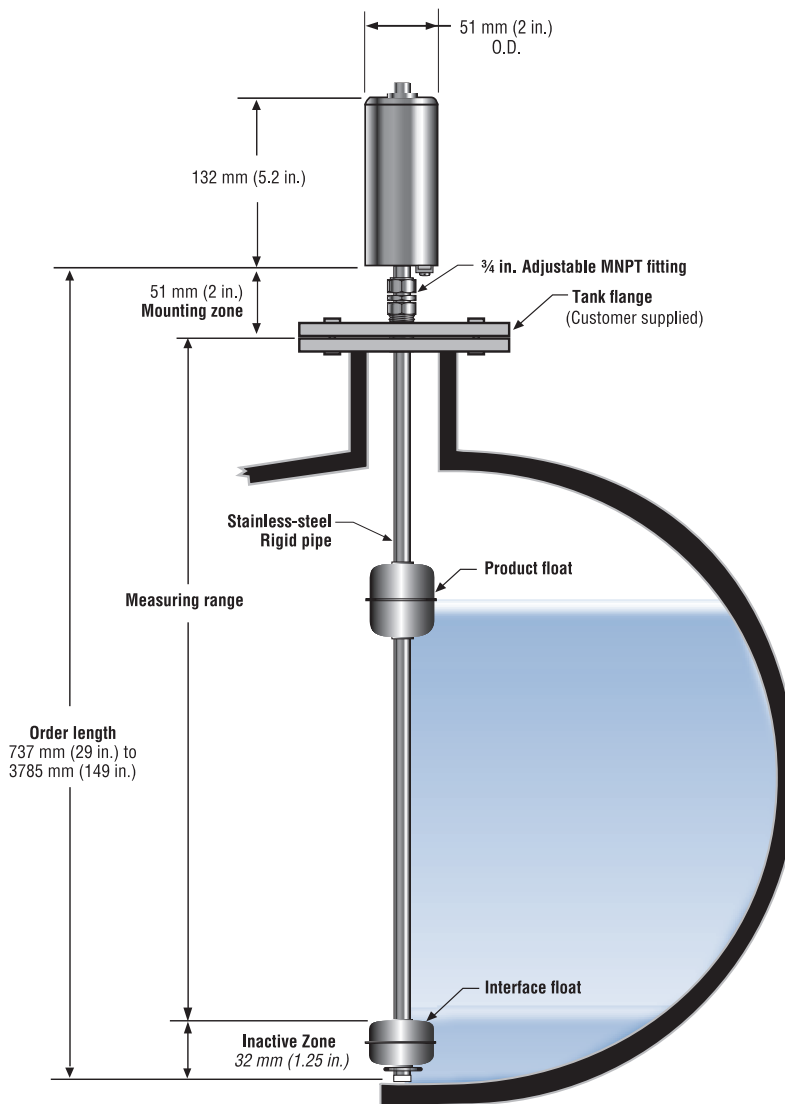

Figure 3. External mounting example

Installation & Mounting

**INTERNAL MOUNT**

MTS offers the Level Plus Model USTD II transmitter configured with a rigid pipe constructed of 316L stainless steel. The rigid pipe configuration can be ordered in lengths from 737 mm (29 in.) to 3785 mm (149 in.). The Model USTD II can be installed using a *Fill Tube Hanger* mount (see illustration below). The fill tube hanger mount allows the transmitter to be installed in the fill tube or riser pipe within the tank and is FM approved.

The 'Measuring range' of the Model USTD II transmitter is equal to the 'Order length' minus the 'Inactive zone' of 32 mm (1.25 in.). The overall length of the transmitter in the tank is equal to the 'Order length' plus the height of the housing and bracket at 176.5 mm (6.95 in.) The Model USTD II transmitter can be ordered with a single product float, or can include the optional interface float. Average and individual temperature measurement from five positions are included.

**\*\* The fill tube hanger mount is not available with ATEX approval**

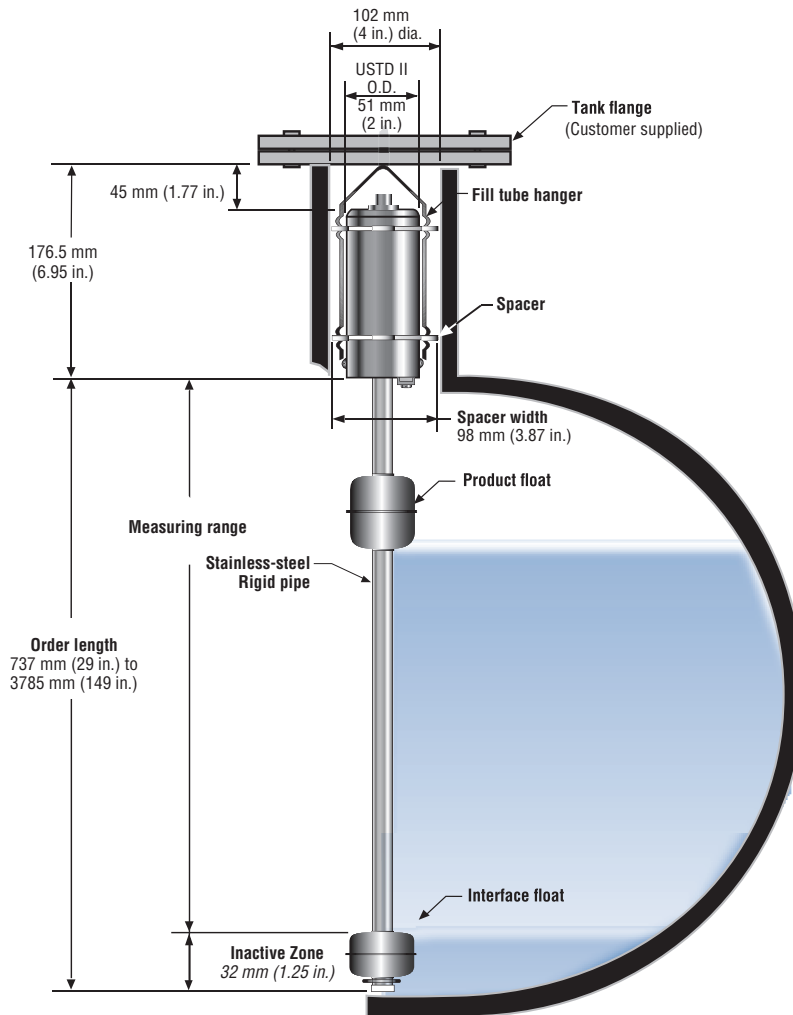

Figure 4. Internal mounting example

## Electrical connections and wiring procedures

A typical intrinsically safe connection for the Level Plus USTD II transmitter includes protective safety barriers, a power supply and a reading or monitoring device. Refer to *Agency information* for detailed information.

### Safety recommendations for installation

Always follow applicable local and national electrical codes and observe polarity when making electrical connections. Never make electrical connections to the M-Series transmitter with power turned on. Make sure that no wire strands are loose or sticking out of the terminal block connection which could short and cause a problem. Make sure that no wire strands, including shield, are in contact with the electronic module enclosure. The electronics module enclosure is grounded through internal circuitry and electrically isolated from the enclosure.

### Industrial topologies

There are four topologies described and illustrated below. However, the daisy chain topology is not recommended by MTS.

#### POINT-TO-POINT

The point-to-point topology consists of having only one device on the loop as shown in *Figure 5*. This topology is not usually used with a bus network since it does not take advantage of placing multiple devices on a loop.

#### BUS WITH SPURS

The bus with spurs topology has a main trunk cable that has each device connected via its own spur at a junction box as shown in *Figure 6*. The bus with spurs and tree topologies can also be used together to form a hybrid topology.

#### TREE ALIGNMENT

The tree topology is very similar to the bus with spurs topology with the main difference of having a common junction box for all of the transmitters as shown in *Figure 7*. Bus with spurs and tree topologies can also be used together to form a hybrid topology.

#### DAISY CHAIN

The daisy-chain topology utilizes a single cable that is connected to all of the transmitters with the cable being interconnected at each field device. When using this topology make sure that the wiring practice allows for one transmitter to be disconnected without disconnecting the entire loop as shown in *Figure 8*. MTS does not suggest using the daisy-chain topology.

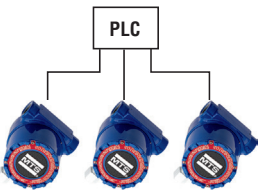

Figure 5. Point-to-point topology

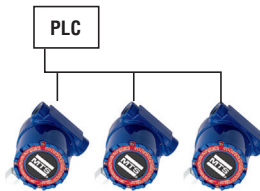

Figure 6. Bus with spurs topology

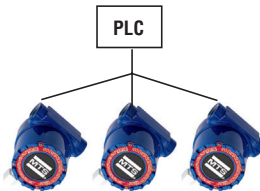

Figure 7. Tree topology

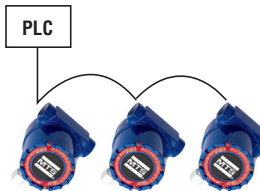

Figure 8. Daisy-chain topology

### Recommended cable types

Listed below are general requirements of cable types for the Level Plus Model USTD II digital transmitter.

#### Cable recommendation:



- Shielded, twisted pair, 24 AWG or heavier
- Minimum 85 °C temperature rating.
- Minimum 0.010 in. (0.25 mm) insulation thickness
- 30 picofarads/foot or less. (see Notes).

**Notes:**

1. The return conductor for the power supply circuit is connected to the shield at the safety barrier ground terminal. When determining the capacitance of cable for the power supply circuit, use the manufacturer's capacitance specifications shown for one conductor and the other conductor connected to the shield.
2. Most cable manufacturers do not list inductance properties for cables. Where the inductance properties are unavailable, ISA RP12.6 (Installation of Intrinsically Safe Instrument Systems in Class I Hazardous Locations) recommends the use of 0.2 µH (micro henries) per foot as a value for cable inductance.
3. Termination and biasing of RS-485 data lines are as follows:
  - **Biasing** - Each M-Series transmitter has internal high impedance biasing resistors (30K Ω) on both RS-485 data lines. No additional biasing resistors should be present on the connecting devices (PLC, DCS, PC, converter).
  - **Termination** - Each M-Series transmitter has an internal termination resistor (100K Ω) installed across the RS-485 signal lines. No additional termination resistors are necessary in the connecting devices (PLC, DCS, PC, converter).

**Grounding**

The USTD II must have a dedicated earth ground connected to the housings' ground lug. Refer to Agency information for more information.

**Safety barriers**

**Entity Parameter**

FM	V <sub>max</sub> = 28 Vdc I <sub>max</sub> = 200 mA C <sub>i</sub> = 0µF L <sub>i</sub> = 0 mH
ATEX	U <sub>i</sub> = 28 Vdc I <sub>i</sub> = 200 mA C <sub>i</sub> = Negligibly low L <sub>i</sub> = Negligibly low

Supplier	Type	Maximum voltage	Maximum current	Maximum power	Maximum resistance	Number of channels
STAHL	9001/01-280-165-101	28 Vdc	165 mA	1155 mW	198Ω	1
STAHL	9001/01-280-110-101	28 Vdc	110 mA	770 mW	294Ω	1
MTL	728	28 Vdc	93 mA	651 mW	300Ω	1
MTL	728+	28 Vdc	93 mA	651 mW	300Ω	1
MTL	7028+	28 Vdc	93 mA	651 mW	300Ω	1
MTL	7128+	28 Vdc	93 mA	651 mW	300Ω	1
MTL	7728+	28 Vdc	93 mA	651 mW	300Ω	1

**Table 2.** Power supply (+24 Vdc)

Supplier	Type	Maximum voltage	Maximum current (each channel)	Maximum power (each channel)	Maximum resistance (each channel)	Number of channels
STAHL	9001/01-086-010-101	8.6 Vdc	10 mA	21.5 mW	963Ω	1
STAHL	9002/11-120-024-001	12 Vdc	12 mA	70 mW	1156Ω	2
MTL	764+	12 Vdc	24 mA	72 mW	1075Ω	2

**Table 3.** Communication lines (TX/RX+ and TX/RX-)

## Model USTD II Operation and Installation Manual Maintenance and Field Service

### Maintenance and field service

---

This section contains information about post installation maintenance and provides an overview of MTS Sensors' repair and replacement procedures.

### General maintenance and field service requirements

---

**Notes:**

Please contact Technical Support or Customer Service for help when damage occurs in order to obtain a return materials authorization (RMA) number. Packages without a RMA number may be rejected. Any unit that was used in a process must be properly cleaned in accordance with OSHA standards, before it is returned to the factory. A Material Safety Data Sheet (MSDS) must accompany material that was used in any media.

### FLOAT MAINTENANCE

Level Plus M-Series transmitters use magnetostrictive technology and only have one moving part—the float. This technology ensures no scheduled maintenance or recalibration is required. However, MTS recommends that you check the transmitter pipe annually for build up of process material. Floats should move freely along the pipe. If they do not, routine cleaning should be performed.

### FIELD SERVICE

If damage does occur to a M-Series transmitter, the transmitter can be serviced in the field with replacement parts. Please contact Technical Support for detailed steps of field replacement.

### SERVICE / RMA POLICY

If the customer suspects their transmitter is damaged or not functioning correctly, call *MTS Technical Support* for further instruction. If it is necessary to return the transmitter to the factory, an RMA number is required and can only be issued by Technical Support. Product returns that do not include an RMA will be returned to the customer. MTS evaluates the transmitter and advises the customer whether a repair or replacement is necessary and any cost that might be incurred. If the customer declines repair/replacement or the transmitter has no fault found, the unit is sent back as is and the customer is charged with a standard evaluation fee.

If the transmitter is under warranty and a manufacturer's defect is detected, there will be no cost to the customer for repair or replacement. If the transmitter is out of warranty or if the customer has damaged the transmitter, a repair or replacement quote will be provided. In specific cases where the transmitter can not be removed and returned to the factory for evaluation, field evaluations can be performed in the field by an MTS technician. If field evaluation must be performed, the customer is responsible for all expenses incurred for travel, evaluation, parts and repair time. However, if the transmitter is under warranty and the problem is due to a manufacturer's defect, there is no cost to the customer for replacement parts. To discuss all service options, contact *Technical Support*.

## Troubleshooting

Table 4 below contains troubleshooting information for the Model USTD II digital transmitter.

### Troubleshooting procedures

Symptom	Possible Cause	Action
<b>No communication with transmitter</b>	No power	Check voltage at transmitter
	Wiring incorrect	Reference installation drawing ( <i>see 'Electrical connections and wiring'</i> )
	Wrong address	DDA factory default is '192'
	Wrong software	Confirm correct software
	Wrong protocol	Confirm software and transmitter are same protocol
<b>Missing magnet error</b>	Float not recognized	Confirm that the float is attached
	Float is in the dead zone	Raise float to see if the error stops
<b>Trigger level error</b>	Gain needs to be adjusted	Consult Factory
	SE is damaged	Consult Factory
	Min. trigger level too high	Consult Factory

**Table 4.** Troubleshooting reference

### Quick start-up guide

#### BEFORE YOU BEGIN

**Note:**

You must use a RS-485 converter with “*Send Data Control*” and the M-Series Set-up Software to ensure proper operation.

*Example:*

B & B Electronics 485BAT3 (815-433-5100 www.bb-elec.com).

**Default communication parameters**

USTD: 4800 BAUD	8, E, 1
-----------------	---------

#### QUICK START-UP PROCEDURE

1. Connect +24 Vdc to terminals.
2. Connect data lines to terminals.
3. Connect the PC (or other device) to data lines.  
(If you are using a PC, use a RS-232 to RS-485 converter. See *Note* above for more information.)
4. Turn on power to the transmitter.
5. Start the M-Series Setup Software. Click the ‘**Data From Device**’ tab. Click the ‘**Device**’ pull down menu (located in the upper right corner of the window) to verify communications using factory default address ‘192’ for DDA.
6. Change the address to one that is suitable for the installation network.
7. Verify proper operation of product and or interface floats and temperature.
8. Turn off power to the transmitter.
9. Remove data lines.
10. Install the transmitter into the vessel (*see Installation and mounting*).
11. Reconnect power and data lines.
12. Verify communications with the host system (*repeat step 5*).
13. Calibrate current tank level (optional). Setup is complete.

## DDA user interface

---

### COMMUNICATION PROTOCOL

The communication is based on a RS485 network which allows up to 32 transceivers to be connected. The transmission speed is 4800 baud. Each word consists of 11 bits; 1 start, 1 stop, 8 data and 1 even parity bit.

The communication follows a master/slave principle. All gauges operate in a passive mode until the master requests a certain action from one of them.

When an action is requested, the first byte the master sends is an address byte in the range of C0-FD hex. The second byte is a command byte which tells the addressed gauge what action to take.

For example C2 0A requests the following action: "sensor name C2 measure the first float and send the result in 0.1 inch resolution.

First the addressed gauge sends an acknowledgement by repeating these two bytes (echo). Then the gauge performs the required action and sends the data as an ASCII string. To provide an efficient integrity test, the gauge calculates a checksum and sends it as a 5 digit ASCII decimal value to the master. This value is the 2's complement of the sum of the data string bytes (including STX and ETX ). The master adds this value to the sum of the received bytes (except the echo) for a result of zero.

### COMMUNICATION TIMING

The byte time is given by the transmission speed (4800 baud) as .3ms. The bytes can be transmitted without any additional delay between them, but if there is, it should not exceed 5ms. When the command byte is also transmitted, the master should disable its driver to allow the gauge to send the echo.

The time between the end of command byte transmission and the echo can vary from 19 ms to 25 ms. The time between the echo and the beginning of the data transmission can vary between zero (when the function is aborted because of an error) and TMAX which is given in the USTD II command set table on page 16.

### COMMAND 02

All gauges are delivered with the address C0. To configure your network of gauges, address C0 must be changed by using the command 02.

You can configure your network using two methods. Programming the network using the following method requires the serial number for each sensor (access code) that is mounted on each tank:

To select a single gauge, use address FF and command byte 02. An access code string (which is equal to the serial number and unique to each sensor), is transmitted by the master. The following is an example of the access code: <SOH>FN12345678<EOT>.

If a sensor receives its access code it responds with the current address <STX>192<ETX> (+ checksum) to flag that it is ready to receive the new address. Within 500ms the master can now transmit the new address for xample <SOH>193<EOT> (C1). When the new address is successfully written in the sensors nonvolatile memory (EEPROM) the sensor transmits an <ACK> (+ checksum).

The second method is to reserve the address C0 for gauges that are added to the network. Then the gauges can be linked to the network one by one, while an intelligent software reads the access code in the device information of the newly added or replaced gauge (C0 4F) and uses this to program the desired address.

USTD II COMMAND SET TABLE

Command code (hex) and name	Possible answers	TMAX in ms
C0 01	“STX DDA ETX”	115
FF 02 “SOH {access code} EOT” “SOH a a a EOT”	“STX a a a ETX” or no response “ACK” or no response	115 800
C0 0A Output level 1 ( product ) at 0.1 inch resolution	C0 0A “STX d d d d . d ETX” C0 0A “STX E 1 0 2 ETX”	800
C0 0B Output level 1 ( product ) at 0.01 inch resolution	C0 0B “STX d d d d . d d ETX” C0 0B “STX E 1 0 2 ETX”	800
C0 0C Output level 1 ( product ) at 0.001 inch resolution	C0 0C “STX d d d d . d d d ETX” C0 0C “STX E 1 0 2 ETX”	800
C0 10 Output level 1 ( product ) and level 2 ( interface ) at 0.1 inch resolution	co 10 “STX d d d d . d : d d d d . d ETX” C0 10 “STX E 1 0 2 : E 1 0 2 ETX”	800
C0 11 Output level 1 ( product ) and level 2 ( interface ) at 0.01 inch resolution	C0 11 “STX d d d d . d d : d d d d . d d ETX” C0 11 “STX E 1 0 2 : E 1 0 2 ETX”	800
C0 12 Output level 1 ( product ) and level 2 ( interface ) at 0.001 inch resolution	C0 12 “STX d d d d . d d d : d d d d . d d d ETX” C0 12 “STX E 1 0 2 : E 1 0 2 ETX”	800
C0 19 Average temperature at 1 degree Fahrenheit resolution	C0 19 “STX d d d d ETX” C0 19 “STX E 2 0 1 ETX”	800
C0 1A Average temperature at 0.1 degree Fahrenheit resolution	C0 1A “STX d d d d . d ETX” C0 1A “STX E 2 0 1 ETX” C0 1A “STX E 2 12 ETX”	800
C0 1B Average temperature at 0.01 degree Fahrenheit	C0 1B “STX d d d d . d d ETX” C0 1B “STX E 2 0 1 ETX”	800
C0 1F Average and individual DT temperature at 1 degree Fahrenheit resolution	C0 1F “STX d d d d : d d d d : ... : d d d d ETX” C0 1F “STX E 2 0 1 : d d d d : ... : d d d d ETX” C0 1F “STX E 2 12 : d d d d : ... : d d d d ETX”	800
C0 20 Average and individual DT temperature at 0.1 degree Fahrenheit resolution	C0 20 “STX d d d d . d : d d d d . d : ... : d d d d . d ETX” C0 20 “STX E 2 0 1 : d d d d . d : ... : d d d d . d ETX” C0 20 “STX E 2 12 : d d d d . d : ... : d d d d . d ETX”	800
C0 21 Average and individual DT temperature at 0.01 degree Fahrenheit resolution	C0 21 “STX d d d d . d d : d d d d . d d : ... : d d d d . d d ETX” C0 21 “STX E 2 0 1 : d d d d . d d : ... : d d d d . d d ETX” C0 21 “STX E 2 12 : d d d d . d d : ... : d d d d . d d ETX”	800
C0 4D Read level offset data	C0 4D “STX d d d d . d d d : d d d d . d d d ETX”	115
C0 4F Read device info	C0 4F “STX O . N . = {ordering number} : F . N . = {factory number} : A . C . = {access code} : V 3 . 08_ETX”	115
C0 57 “SOH c : d d d d . d d d EOT” Set offset for float c	C0 57 “STX c : d d d d . d d d ETX”	115

DDA User Interface

## Model USTD II Operation and Installation Manual

### DDA User Interface

Notes:		
C0	Gauge address byte	possible range: C0 - FD
**	Includes ASCII strings	
a a a	Address in characters	possible range: 192 - 255
d d d d . d d d	Numbers in characters	supressed are: leading zeros and positive sign (+)
(access code)	Unique code, 10 ASCII characters (FN+serial number)	example: 12345678
(ordering number)	See ordering documents, 14 ASCII characters	example: USTDII - M256569
(serial number)	8 ASCII characters	example: 98010001

### USTD II ERROR CODES

E102	Missing float	A level request has been made with no level data returned.
E212	DT communication error	A DT is shorted or open or has been set to 'not active'.
E201	No DT's programmed	DT's are not active or there are no DT's.

## USTD II Digital setup software installation, setup and calibration

Adjustments to the calibration and set up parameters of the transmitter can be performed using the M-Series Digital Setup Software package. The software can be run from any PC using a RS-485 to RS-232 converter (see Table 10 MTS part number references). In the 'MTS Digital Gauge Configuration - DDA - USTD II' window, you will see one tab labeled 'Data From Device' (see Figure 9). You will use this tab and its button selections to calibrate the transmitter and change setup parameters.

**Note:**

You must use a RS-485 converter with 'Send Data Control' when using the M-Series Digital Setup software to ensure proper operation.  
*Example:* B & B Electronics 485BAT3 (815-433-5100 www.bb-elec.com).

<b>Level Plus M-Series PC Digital Setup Software (DDA) CD</b>	<b>RS-485 to RS-232 converter</b>
Order number: 625053	Order number: 380075

Table 10. MTS part number references

### DATA FROM DEVICE TAB

Perform the following steps to install the transmitter setup software to establish communications with the transmitter:

1. Install Setup Software from the CD that came with your transmitter or go to [www.mtssensors.com](http://www.mtssensors.com) to download the latest version.
2. Connect transmitter to the RS-485 to RS-232 converter and attach the converter to your PC. Some PC's will require an additional Serial to USB converter.
3. Open the Software program.
4. Select **COM Port**. If you do not know which COM port to select, right click **My Computer** and select **Properties -> Hardware Tab -> Device Manager -> Ports (COM & LPT)** to view the list.
5. Click the 'Data From Device' tab, click the **Device:** pull-down and select the 'transmitter address', the factory default for DDA is **192** (see Figure 9).

Parameter settings and calibration is performed from within the Data From Device tab window (see Figure 9).

### DATA FROM DEVICE tab options:

- Calibrate
- Change Address
- COM port
- Adjust
- Backup and restore device settings

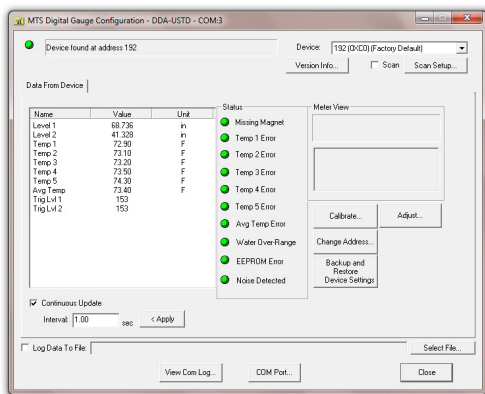

Figure 9. Data from device tab

### CALIBRATION

When you click the 'Calibrate' button in the 'Data From Device' tab window, the 'Calibrate DDA Device' window opens. There are two calibration 'Float Methods' to choose from, from the drop down menu select a calibration method. 'Enter Float Positions (Calibrate)' and 'Enter Float Zero Positions'. Click the 'Offset Method:' Select 'Enter Float Positions (Calibrate)' and enter the current position of the float. Type a value in the active field, then click the 'Send' button. A confirmation window displays when the send is successful.

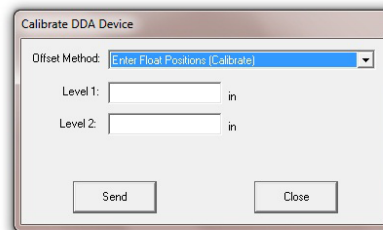

Figure 10. Calibrate - Enter float positions

When you choose 'Enter Float Zero Positions' from the 'Offset Method:' drop down menu, you can adjust the offset where the transmitters zero point is located. This adjustment will significantly shorten the span of the transmitter or counter inactive zones. Adjust the value accordingly and click 'Send'. A confirmation window displays when the send is successful.

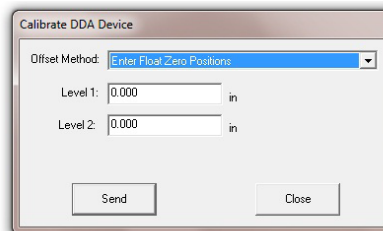

Figure 11. Calibrate - Enter float zero positions

DDA User Interface

## Model USTD II Digital Operation and Installation Manual

### DDA User Interface

#### CHANGE ADDRESS

To change the transmitter address, click the **'Change Address'** button in the *'Data From Device'* tab window. In the *'Change Address'* window, type the Serial Number and **'New Address'** in the active field and click *'Change'*. A popup window confirms the change is successful.

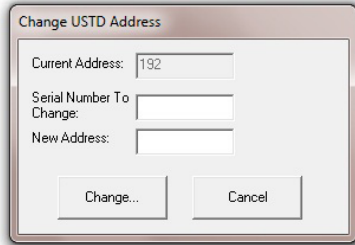

Figure 12. Change Address window - New Address entry

#### BACKUP AND RESTORE DEVICE SETTINGS

If your electronics requires a replacement or if your current settings need to be refreshed, it is recommended that you create a backup or restoration file. To create a backup, click the **'Backup/Restore'** button in the *'Data From Device'* tab window. In the *'Backup and Restore Device Settings'* window, click the **'Get Data From Sensor'** button and **'Save Settings to File'** button. When prompted, save the file to a designated place where you can find it.

To upload a file, click the **'Read Settings from File'** button and select your backup file. Click **'Write Data to Sensor'**. A popup window confirms the upload is successful.

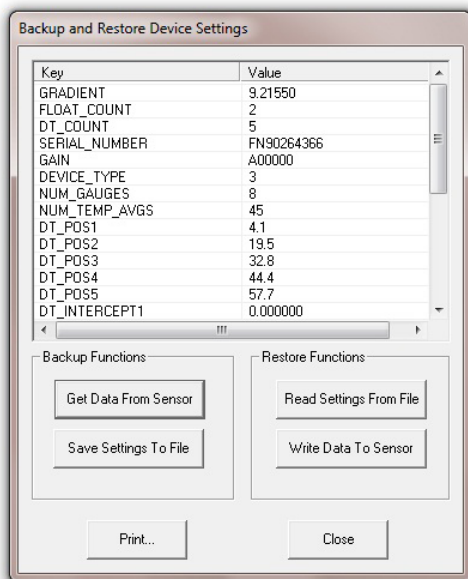

Figure 13. Backup and Restore Device Settings window

#### Adjust settings

To adjust settings, click the **'Adjust'** button located in the *'Data From Device'* tab window (see Figure 9). The *'Adjust DDA Gain'* window displays different parameter settings. All transmitters will have the ability to adjust the *'Gain, SARA Blanking and Magnet blanking'* from this menu. These parameters are password protected, changes will

require assistance from *MTS Technical Support*.

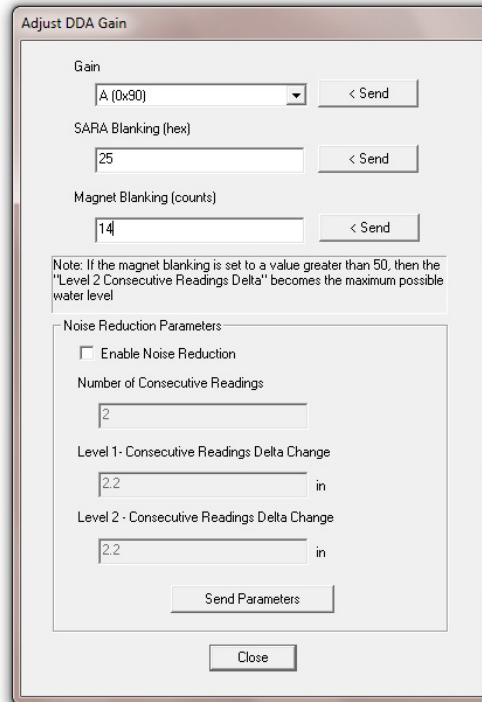

Figure 14. Adjust DDA Gain window

#### COM PORT

To select the Setup Software communication port, click the **'COM Port'** button in the *'Data From Device'* tab window. Select the appropriate communication port and click **'OK'**.

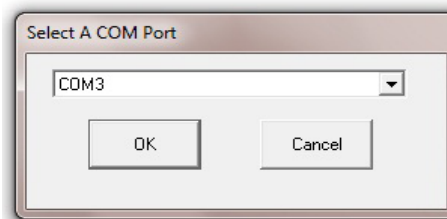

Figure 15. Select a COM Port window

#### CONTINUOUS UPDATE

To view realtime data using the Setup Software interface, select the **'Continuous Update'** box. The Interval may be changed to slow down updates but is not necessary.

#### DATA LOGGING

To download a transmitter data log, Click **'Select File'** in the *'Data From Device'* tab window. Select an Excel file and check the **'Log Data to File'** box to save your data.



## Agency approvals

### Intrinsically Safe

<b>FM 3610</b>	Class I, Division 1, Groups A, B, C and D Type 4X Ta = 71° C
<b>EN 50020</b>	PTB 04 ATEX 2107 X  II 1/2 G bzw. II 2 G EEx ia IIB T4 bzw. EEx ia IIA T4 Ta = -20° C to +80° C
<b>GB3836.4-2010</b>	Ex ia IIC T4 Ga Ta = -40° C to +71° C

Hazardous area installation

FM

AGENCY CONTROLLED DRAWING. NO CHANGES WITHOUT PRIOR AGENCY APPROVAL

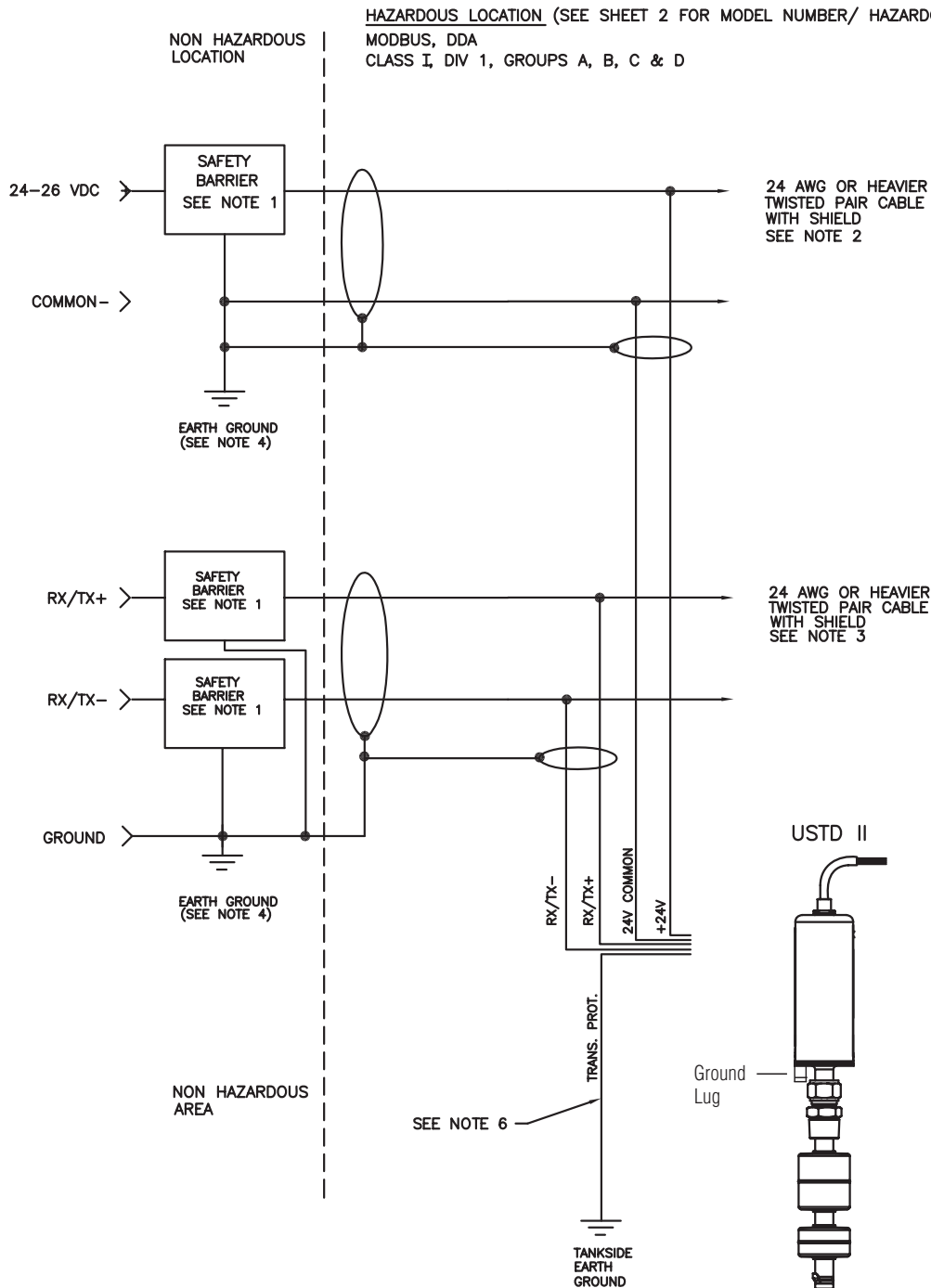

Figure 16. USTD II installation drawing

**INSTALLATION DRAWING NOTES (FIGURE 16)**

**Notes:**

1. Safety barriers are FMRC approved with entity parameters and must be used in an approved configuration where the following conditions are met:
  - $V_{oc}$ , or  $V_t$  of the barrier combination is less than  $V_{max}$  of the transmitter.
  - $I_{sc}$ , or  $I_t$  of the barrier combination is less than  $I_{max}$  of the transmitter.
  - $C_a$  of the barrier combination is greater than the total  $C_i$  of the transmitters plus the cable capacitance.
  - $L_a$  of the barrier combination is greater than the total  $L_i$  of the transmitters plus the cable capacitance.
  - Total  $L_i$  of the transmitters plus the cable capacitance.

*Transmitter entity parameters:*

$V_{max} = 28 \text{ Vdc}$

$I_{max} = 200 \text{ mA}$

$C_i = 0 \text{ Li} = 0$

2. Power supply cable must be 24 awg or heavier, shielded twisted pair cable. Cable capacitance must be less than 30pF per foot. Cable shield is connected to system ground at safety barrier end only. See installation manual for additional cable information.
3. Communications cable must be 24 awg or heavier, shielded twisted pair cable. Cable capacitance must be less than 30pF per foot. Cable shield is connected to system ground at safety barrier end only. See installation manual for additional cable information.
4. The wire connection between earth ground and the safety barrier ground terminal must be less than 1 ohm.
5. Maximum approved number of DDA gauges for intrinsically safe wiring networks is 8. See operation and installation manual for system configurations and restrictions.
6. Connection to earth ground for transient protection circuitry.
7. Ground screw provided to connect gauge housing to earth ground.
8. The transducer frame shall be grounded to earth ground directly or through the equipment on which it is mounted and shall be at the same potential as the safety barrier ground electrode.
9. Electronic equipment connected to associated apparatus must not use or generate more than 250 volts RMS.
10. Cable sets that are run together must have sufficient insulation to withstand 250 volts RMS between sets.
11. All wiring must meet the requirements of the NEC and any local codes.

**WIRING CONNECTIONS**

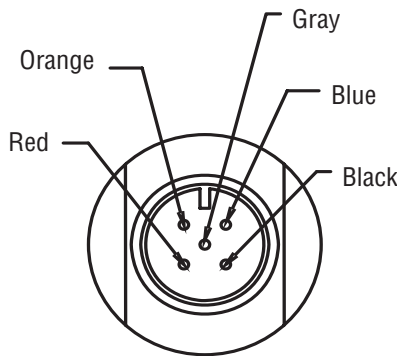

Wiring diagram	
Color	Signal
Red	24 Vdc Power
Black	0 Vdc Power
Gray	Earth ground
Blue	TXD RXD +
Orange	TXD RXD -

**Figure 17.** USTD II housing with connector

**Model USTD II Digital Operation and Installation Manual**

**Agency Information**

**PRODUCT LABEL**

	<p><b>Level Plus<sup>®</sup></b> <b>M-Series</b></p>
<p><b>MTS Systems Corporation</b> Sensors Division 3001 Sheldon Drive, Cary, NC 27513 Telephone 919-677-0100 FAX 919-677-0200</p>	
<p>Model No.: USTDII _____ Serial No.: XXXXXXXXXX Date Code: XX/XX Length: XXX</p>	
<p>DT location</p>	
<p>Patent numbers: 5,070,485; 5,367,255, 5,334,933; 5,311,124; 5,587,680; 5,848,549; 4,952,873; 5,545,984; 5,590,091; 5,736,855</p>	
<div style="border: 1px solid black; padding: 2px; width: fit-content; margin-bottom: 5px;"> <p style="text-align: center; margin: 0;">FM</p> <p style="text-align: center; font-size: 8px; margin: 0;">APPROVED</p> </div> <p>Temp Code: T4 Enclosure Type: 4X Vmax: 28V, I max: 200 mA, Ci = 0μF Li = 0μH</p>	<p style="text-align: center;">Intrinsically Safe CL. I DIV 1 Gr. A,B,C,D when connected in accordance with FM approved installation drwg.# 650838</p>
<div style="border: 1px solid black; padding: 2px; display: inline-block;"> <b>WARNING</b> </div>	<p><b>Substitution of components may impair intrinsic safety.</b></p>

**Figure 18.** Label for model USTDII\_\_\_\_\_HS, AS

ATEX

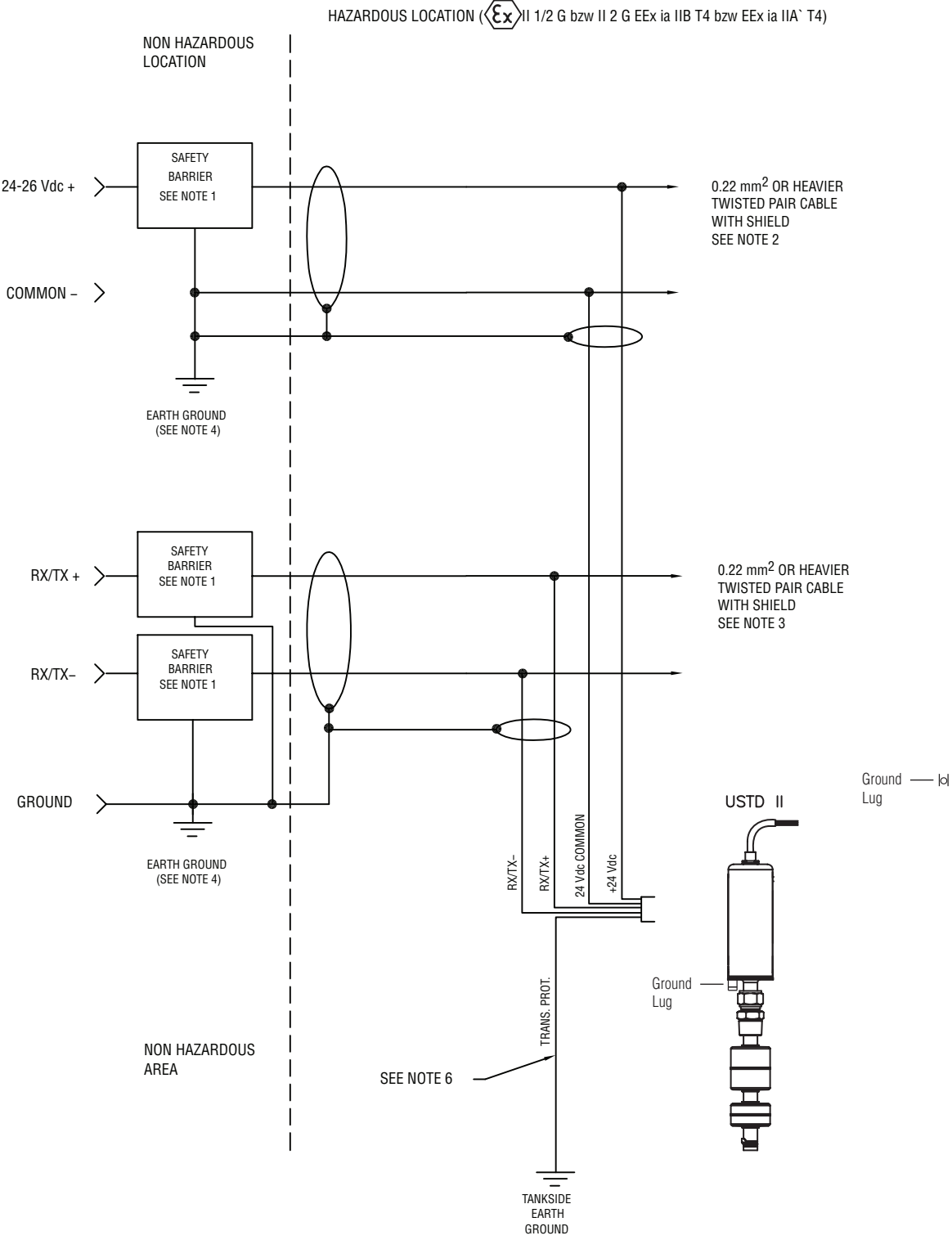

Figure 19. ATEX for DDA installation drawing

**INSTALLATION DRAWING NOTES (FIGURE 19)**

**Notes:**

1. Safety barriers are ATEX Certified with entity parameters and must be used in an approved configuration where the following conditions are met:
  - Uo of the barrier combination is less than Ui of the transmitter.
  - Io of the barrier combination is less than Ii of the transmitter.
  - Co of the barrier combination is greater than the total Ci of the transmitters plus the cable capacitance.
  - Lo of the barrier combination is greater than the total Li of the transmitters plus the cable capacitance.
 Transmitter entity parameters:
  - Vmax = 28 Vdc
  - Imax = 200 mA
  - Ci = negligibly low
  - Li = negligibly low
2. Power supply cable must be 0,22 mm<sup>2</sup> or heavier (e.g. 1.32 mm<sup>2</sup> AWG 16), shielded twisted pair cable. Cable capacitance must be less than 160 pF/m. Cable shield is connected to system ground at safety barrier end only.
3. Communications cable must be 0.22 mm<sup>2</sup> or heavier (e.g. 1.32 mm<sup>2</sup> AWG 16), shielded twisted pair cable. Cable capacitance must be less than 160 pF/m. Cable shield is connected to system ground at safety barrier end only.
4. The wire connection between earth ground and the safety barrier ground terminal must be less than 1 ohm.
5. Maximum approved number of DDA or MODBUS gauges for intrinsically safe wiring networks is 6 to 8. Contact factory for Modbus applications.
6. Connection to earth ground for transient protection circuitry.
7. Ground screw earthing hardware provided to connect gauge housing to earth ground.
8. The transducer frame shall be grounded to earth ground directly or through the equipment on which it is mounted and shall be at the same potential as the safety barrier ground electrode.
9. Electronic equipment connected to associated apparatus must not use or generate more than 250 volts RMS.
10. Cable sets that are run together must have sufficient insulation to withstand 250 volts RMS between sets.
11. All wiring must meet the local regulations and/or other national/international standards.

**WIRING CONNECTIONS**

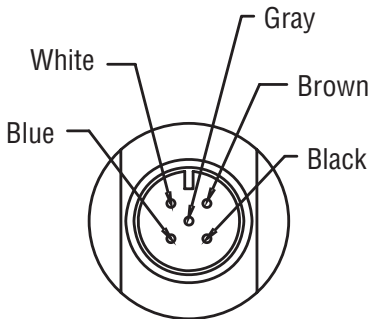

Wiring diagram	
Color	Signal
Blue	24 Vdc Power
Black	0 Vdc Power
Gray	Earth ground
Brown	TXD RXD +
White	TXD RXD -

**Figure 20.** USTD II housing with connector

PRODUCT LABEL

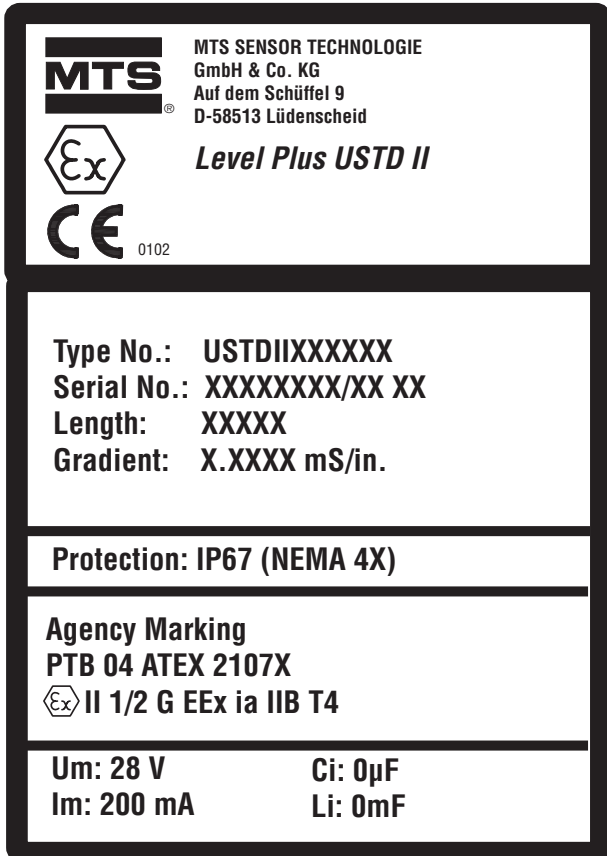

Figure 21. Label for USTDII \_ \_ \_ \_ \_ 69, 67

**Model USTD II Digital Operation and Installation Manual**

**Agency Information**

**NEPSI INSTALLATION DRAWING**

AGENCY CONTROLLED DRAWING. NO CHANGES WITHOUT PRIOR AGENCY APPROVAL

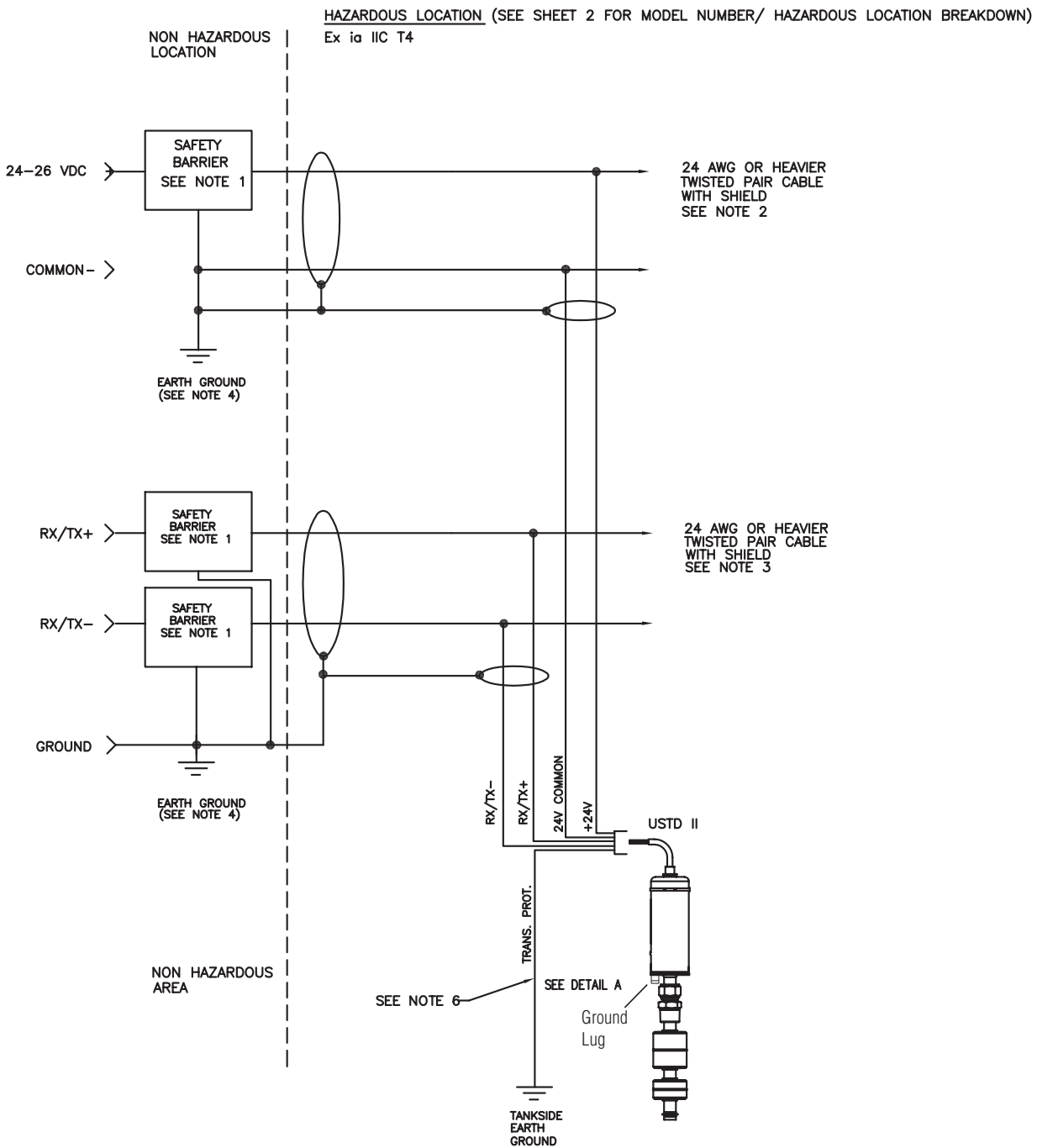

**Figure 22.** NEPSI Installation drawing



**INSTALLATION DRAWING NOTES (FIGURE 22)**

**Notes:**

1. Safety barriers are NEPSI approved (as applicable) with entity parameters and must be used in an approved configuration where the following conditions are met.
  - $V_{oc}$ , or  $V_t$  of the barrier combination is less than  $V_{max}$  of the transmitter.
  - $I_{sc}$ , or  $I_t$  of the barrier combination is less than  $I_{max}$  of the transmitter
  - $C_a$  of the barrier combination is greater than the total  $C_i$  of the transmitters plus the cable capacitance.
  - $L_a$  of the barrier combination is greater than the Total  $L_i$  of the transmitters plus the cable capacitance.

*Transmitter entity parameters:*

$V_{max}$  - 28 V  
 $I_{max}$  = 200 mA  
 $C_i$  = 0  
 $L_i$  = 0

2. Power supply cable must be 24 awg or heavier, shielded twisted pair cable. Cable capacitance must be less than 50pF per foot. Cable shield is connected to system ground at safety barrier end only. See installation manual for additional cable information.
3. Communications cable must be 24 awg or heavier, shielded twisted pair cable. Cable capacitance must be less than 24pF per foot. Cable shield is connected to system ground at safety barrier end only. See installation manual for additional cable information.
4. The wire connection between earth ground and the safety barrier ground terminal must be less than 1 ohm.
5. Maximum approved number of DDA gauges for intrinsically safe wiring networks is 8. See operation and installation manual for system configurations and restrictions.
6. Connection to earth ground for transient protection circuitry.
7. Ground screw provided to connect gauge housing to earth ground.
8. The transducer frame shall be grounded to earth ground directly or through the equipment on which it is mounted and shall be at the same potential as the safety barrier ground electrode.
9. Electronic equipment connected to associated apparatus must not use or generate more than 250 volts RMS.
10. Cable sets that are run together must have sufficient insulation to withstand 250 volts RMS between sets.
11. All wiring must meet the requirements of the NEC or CEC Part I (whichever is applicable) and any local codes.

**WIRING CONNECTIONS:**

Wiring diagram	
Color	Signal
Red	24 Vdc Power
Black	0 Vdc Power
Gray	Earth ground
Blue	TXD RXD +
Orange	TXD RXD -

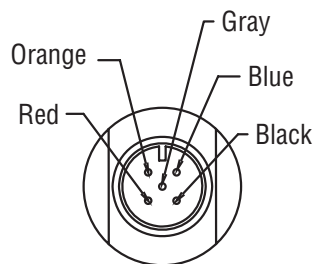

**Figure 23.** NEPSI Wiring

**Figure 23.** NEPSI Wiring

PRODUCT LABEL

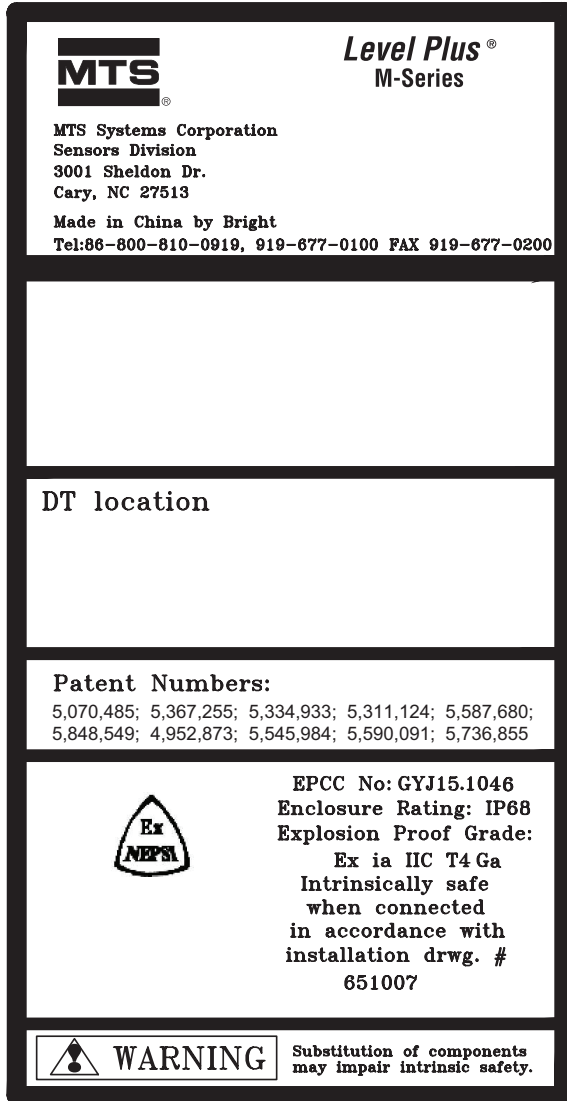

Figure 24. NEPSI Product label



Member of the FM Global Group

FM Approvals  
1151 Boston Providence Turnpike  
P.O. Box 9102 Norwood, MA 02062 USA  
T: 781 762 4300 F: 781-762-9375 www.fmapprovals.com

## CERTIFICATE OF COMPLIANCE

### HAZARDOUS (CLASSIFIED) LOCATION ELECTRICAL EQUIPMENT

This certificate is issued for the following equipment:

**MGAabcdefghijkl. M-Series Digital Level Transmitters.**

XP / I / 1 / BCD / T6 Ta = 71°C; DIP / II,III / EFG / T6 Ta = 71°C; Type 4X

IS / I,II,III / 1 / ABCDEFG / T4 Ta = 71°C - 650838; Entity; Type 4X

NI / I / 2 / ABCD / T4 Ta = 71°C; Type 4X

Entity Parameters:

$V_{Max} = 28 V$ ,  $I_{Max} = 200 mA$ ,  $C_i = 0 \mu F$ ,  $L_i = 0 mH$ .

a = Output M, D, O, N or T.

b = Housing Type A, B, C, D, E, L, 3, 6, 7, 8 or 9 (A, 3, 9 are IS only) (L, 8 are IS, Class I only) (B, C, D, E, 6, 7 are XP or IS).

c = Electronics Mounting 1, 3, 4, 5 or 6.

d = Sensor Pipe B, C, D, E, F, M, N, P, R, S, T, U, 1, 2 or 3.

e = Material of Construction 1, 2, 3, 9, A or C.

f = Process Connection Type 1, 4, 5, 6, 7, 8 or X.

g = Process Connection Size A, B, C, D, E, F, G, H, J or X.

h = DT 0, 1, 2, 5, 6, 7, 8, 9, A, B, C, D, E, F, G, H, J, K or L.

i = Unit of Measure M or U.

j = Length.

k = Special S, E or R.

**MGAabcdefghijkl. M-Series Digital Level Transmitters.**

XP / I / 1 / BCD / T6 Ta = 71°C; DIP / II,III / 1 / EFG / T6 Ta = 71°C; Type 4X

a = Output M, D, F, O, N, S or T.

b = Housing Type B, C, D, E, 6 or 7.

c = Electronics Mounting 1, 3, 4, 5 or 6.

d = Sensor pipe B, C, D, E, F, M, N, P, R, S, T, U, 1, 2, or 3.

e = Material of Construction 1, 2, 3, 9, A or C.

f = Process Connection Type 1, 4, 5, 6, 7, 8 or X.

g = Process Connection Size A, B, C, D, E, F, G, H, J or X.

h = DT 0, 1, 2, 5, 6, 7, 8, 9, A, B, C, D, E, F, G, H, J, K or L.

i = Unit of Measure M or U.

j = Length.

To verify the availability of the Approved product, please refer to [www.approvalguide.com](http://www.approvalguide.com)

FM Approvals HLC  
04/13

3006790  
Page 1 of 4



k = Special S, E or R.

**USTD II abcdef M-Series Digital Level Transmitters.**

IS / I / 1 / ABCD / T4 Ta = 71°C - 650838; Entity; Type 4X

Entity Parameters:

V<sub>Max</sub> = 28 V, I<sub>Max</sub> = 200 mA, C<sub>i</sub> = 0 μF, L<sub>i</sub> = 0 mH.

a = Unit of Measure. M or U.

b = Length (X through XXXX).

c = Process connection type H or A.

d = Cable S or C.

e = Output D or M.

**MRabcdeghijkl M-Series Level Transmitters.**

XP / I / 1 / BCD / T6 Ta = 71°C

DIP / II,III / 1 / EFG / T6 Ta = 71°C; Type 4X

IS / I,II,III / 1 / CDEFG / T4 Ta = 71°C - 650805-1 Entity; Type 4X

Entity Parameters:

V<sub>Max</sub> = 28 V, I<sub>Max</sub> = 118 mA, C<sub>i</sub> = 0 μF, L<sub>i</sub> = 220 μH.

a = Agency Approval A, F, X.

b = Output 1, 2, 3 or 4.

c = Housing type A, B, C, D, E, L, M or 3, V, W, Y or Z (A, L, M or 3 intrinsically safe only).

d = Electronics mounting 1, 2, 3, 4, 5, 6.

e = Sensor pipe B, C, D, E, F, H, J, K, L, R, S, T, U, 1, 2 or 3.

f = Material of construction 1, 2, 3, 9, A or C.

g = Process connection type 1, 3, 4, 5, 6, 7, 8 or X.

h = Process connection size A, B, C, D, E, F, G, H, J or X.

i = RTD 0, 1 or 2.

j = Unit of measure M or U.

k = Length

l = Special S or E.

**MRabcdeghijkl M-Series Level Transmitters.**

XP / I / 1 / BCD / T6 Ta = 71°C

DIP / II,III / 1 / EFG / T6 Ta = 71°C; Type 4X

IS / I,II,III / 1 / DEFG / T4 Ta = 71°C - 650805-1 Entity; Type 4X

Entity Parameters:

V<sub>Max</sub> = 28 V, I<sub>Max</sub> = 118 mA, C<sub>i</sub> = 0 μF, L<sub>i</sub> = 220 μH.

a = Agency Approval A, F, X.

b = Output 1, 2, 3 or 4.

c = Housing type A, B, C, D, E, L, M or 3, V, W, Y or Z (A, L, M or 3 intrinsically safe only).

d = Electronics mounting 1, 2.

e = Sensor pipe B, C, D, E, F, H, J, K, L, R, S, T, U, 1, 2 or 3.

f = Material of construction 1, 2, 3, 9, A or C.

g = Process connection type 1, 3, 4, 5, 6, 7, 8 or X.

h = Process connection size A, B, C, D, E, F, G, H, J or X.

i = RTD 0, 1 or 2.

j = Unit of measure M or U.

k = Length

l = Special S or E.

**MC420abc M-Series Level Transmitters.**

IS / I,II,III / 1 / CDEFG / T4 Ta = 71°C - 650805-1 Entity; Type 4X

Entity Parameters: V<sub>Max</sub> = 28 V, I<sub>Max</sub> = 118 mA, C<sub>i</sub> = 0 μF, L<sub>i</sub> = 220 μH.

a = Length 011 to 216.

To verify the availability of the Approved product, please refer to [www.approvalguide.com](http://www.approvalguide.com)

FM Approvals HLC  
04/13



b = Options 00, F0, T0, FT, 10, R1, R2, R3, R4.  
c = Agency Approval F.

**Equipment Ratings:**

MGA – Explosionproof for Class I, Division 1, Groups B, C, D; Dust-Ignitionproof for Class II, III Division 1, Groups E, F & G; Intrinsically Safe for Class I, II, III Division 1, Groups A, B, C, D, E, F & G Hazardous (Classified) outdoor (Type 4X) locations in accordance with Entity requirements and MTS Installation Drawing 650838

USTD II - Intrinsically Safe for Class I, Division 1, Groups A, B, C, D Hazardous (Classified) outdoor (Type 4X) locations in accordance with Entity requirements and MTS Installation Drawing 650838

MR - Explosionproof for Class I, Division 1, Groups B, C, D; Dust-Ignitionproof for Class II, III Division 1, Groups E, F & G; Intrinsically Safe for Class I, II, III Division 1, Groups C, D, E, F & G Hazardous (Classified) outdoor (NEMA Type 4X) locations in accordance with Entity requirements and MTS Installation Drawing 650805-1

MR - Explosionproof for Class I, Division 1, Groups B, C, D; Dust-Ignitionproof for Class II, III Division 1, Groups E, F & G; Intrinsically Safe for Class I, II, III Division 1, Groups D, E, F & G Hazardous (Classified) outdoor (NEMA Type 4X) locations in accordance with Entity requirements and MTS Installation Drawing 650805-1

MC420 - Intrinsically Safe for Class I, II, III Division 1, Groups C, D, E, F & G Hazardous (Classified) outdoor (NEMA Type 4X) locations in accordance with Entity requirements and MTS Installation Drawing 650805-1

**FM Approved for:**

MTS Systems Corporation  
Sensors Division  
Cary, NC  
USA

To verify the availability of the Approved product, please refer to [www.approvalguide.com](http://www.approvalguide.com)

FM Approvals HLC  
04/13

3006790  
Page 3 of 4



This certifies that the equipment described has been found to comply with the following Approval Standards and other documents:

Class 3600	2011
Class 3610	2010
Class 3615	1989
Class 3810	2005
ANSI/NEMA 250	1991

Original Project ID: 3006790

Approval Granted: March 27, 2000

**Subsequent Revision Reports / Date Approval Amended**

Report Number	Date	Report Number	Date
3008314	July 17, 2000	3041372	March 26, 2012
3008777	September 8, 2000	3045596	June 14, 2013
3009320	October 23, 2000	140607	<i>June 26, 2014</i>
3011770	September 24, 2001		
3010813	November 26, 2001		
3013732	March 18, 2002		
3014667	October 25, 2002		
031113	November 26, 2003		
040115	February 2, 2004		
040624	July 7, 2004		
040830	October 1, 2004		
050915	September 22, 2005		
060424	May 4, 2006		
060619	August 9, 2006		
070917	September 20, 2007		
071024	October 29, 2007		
080310	March 31, 2008		
080430	July 24, 2008		
100720	August 31, 2010		

FM Approvals LLC

  
 J.E. Marquedant  
 Group Manager, Electrical

*26 June 2014*  
 Date

To verify the availability of the Approved product, please refer to [www.approvalguide.com](http://www.approvalguide.com)

FM Approvals HLC  
 04/13

**Physikalisch-Technische Bundesanstalt**  
Braunschweig und Berlin



**EG-Baumusterprüfbescheinigung**

- (1)
- (2) Geräte und Schutzsysteme zur bestimmungsgemäßen Verwendung in explosionsgefährdeten Bereichen - **Richtlinie 94/9/EG**
- (3) EG-Baumusterprüfbescheinigungsnummer  
**PTB 04 ATEX 2107 X**
- (4) Gerät: Füllstands-Transmitter M-Serie-Digital Typen USTD II
- (5) Hersteller: MTS Sensor Technologie GmbH & Co. KG
- (6) Anschrift: Auf dem Schüffel 9, 58513 Lüdenscheid, Deutschland
- (7) Die Bauart dieses Gerätes sowie die verschiedenen zulässigen Ausführungen sind in der Anlage und den darin aufgeführten Unterlagen zu dieser Baumusterprüfbescheinigung festgelegt.
- (8) Die Physikalisch-Technische Bundesanstalt bescheinigt als benannte Stelle Nr. 0102 nach Artikel 9 der Richtlinie des Rates der Europäischen Gemeinschaften vom 23. März 1994 (94/9/EG) die Erfüllung der grundlegenden Sicherheits- und Gesundheitsanforderungen für die Konzeption und den Bau von Geräten und Schutzsystemen zur bestimmungsgemäßen Verwendung in explosionsgefährdeten Bereichen gemäß Anhang II der Richtlinie.  
Die Ergebnisse der Prüfung sind in dem vertraulichen Prüfbericht PTB Ex 04-24333 festgehalten.
- (9) Die grundlegenden Sicherheits- und Gesundheitsanforderungen werden erfüllt durch Übereinstimmung mit  
**EN 50014:1997 + A1 + A2      EN 50020:2002      EN 50284:1999**
- (10) Falls das Zeichen „X“ hinter der Bescheinigungsnummer steht, wird auf besondere Bedingungen für die sichere Anwendung des Gerätes in der Anlage zu dieser Bescheinigung hingewiesen.
- (11) Diese EG-Baumusterprüfbescheinigung bezieht sich nur auf Konzeption und Prüfung des festgelegten Gerätes gemäß Richtlinie 94/9/EG. Weitere Anforderungen dieser Richtlinie gelten für die Herstellung und das Inverkehrbringen dieses Gerätes. Diese Anforderungen werden nicht durch diese Bescheinigung abgedeckt.
- (12) Die Kennzeichnung des Gerätes muß die folgenden Angaben enthalten:



**Ex II 1/2 G bzw. II 2 G    EEx ia IIB T4 bzw. EEx ia IIA T4**

Zertifizierungsstelle Explosionsschutz  
Im Auftrag

Braunschweig, 15. Dezember 2004

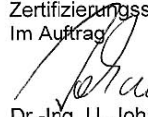
  
Dr.-Ing. U. Johannsmeyer  
Regierungsdirektor



Seite 1/3

EG-Baumusterprüfbescheinigungen ohne Unterschrift und ohne Siegel haben keine Gültigkeit.  
Diese EG-Baumusterprüfbescheinigung darf nur unverändert weiterverbreitet werden.  
Auszüge oder Änderungen bedürfen der Genehmigung der Physikalisch-Technischen Bundesanstalt.

Physikalisch-Technische Bundesanstalt • Bundesallee 100 • D-38116 Braunschweig

# Physikalisch-Technische Bundesanstalt



Braunschweig und Berlin

- (13) **Anlage**
- (14) **EG-Baumusterprüfbescheinigung PTB 04 ATEX 2107 X**
- (15) Beschreibung des Gerätes

Die Füllstands-Transmitter M-Serie-Digital Typen USTD II werden in Behältern zur kontinuierlichen Füllstandmessung von Flüssigkeiten oder zur Messung von Trennschichten in Flüssigkeiten verwendet. Weiterhin wird die Temperatur der Flüssigkeiten erfasst. Die Füllstandsensoren können mit den Schnittstellen Modbus RTU Data Format oder MTS DDA Protokoll versehen sein.

Die Füllstandsensoren bestehen aus einem Elektronikgehäuse mit der zugehörigen Auswerteelektronik, dem Prozessanschlusselement und dem Sensorelement mit Schwimmer.

Je nach Ausführung werden die Füllstandsensoren in explosionsgefährdeten Bereichen der Explosionsgruppe IIA (Kennzeichnung  $\text{Ex}$  II 1/2 G bzw. 2 G EEx ia IIA T4) oder der Explosionsgruppe IIB (Kennzeichnung  $\text{Ex}$  II 1/2 G bzw. 2 G EEx ia IIB T4) verwendet.

Die Varianten sind dem Typschlüssel zu entnehmen.

Kategorie-1/2-Betriebsmittel

Das Elektronikgehäuse wird im explosionsgefährdeten Bereich für Kategorie-2-Betriebsmittel errichtet. Die Prozessanschlusselemente werden in die Trennwand errichtet, die die Bereiche voneinander trennt, in denen Betriebsmittel der Kategorie 2 oder 1 erforderlich sind. Das Sensorelement wird in Bereichen errichtet, die Betriebsmittel der Kategorie 1 erfordern.

Kategorie-2-Betriebsmittel

Die Füllstandsensoren werden in explosionsgefährdeten Bereichen für Kategorie-2-Betriebsmittel errichtet.

Die Zuordnung zwischen höchstzulässiger Umgebungstemperatur und zugeführter Leistung ist der u.a. Tabelle zu entnehmen.

Elektrische Daten

Versorgungs- und Datenstromkreise in Zündschutzart Eigensicherheit EEx ia IIB bzw. EEx ia IIA bzw. EEx ib IIB bzw. EEx ib IIA  
 Nur zum Anschluss an bescheinigte eigensichere Stromkreise.  
 Höchstwerte:  
 $U_i = 28 \text{ V}$   
 $\Sigma I_i = 200 \text{ mA}$   
 $C_i$  vernachlässigbar klein  
 $L_i$  vernachlässigbar klein

Seite 2/3

EG-Baumusterprüfbescheinigungen ohne Unterschrift und ohne Siegel haben keine Gültigkeit.  
 Diese EG-Baumusterprüfbescheinigung darf nur unverändert weiterverbreitet werden.  
 Auszüge oder Änderungen bedürfen der Genehmigung der Physikalisch-Technischen Bundesanstalt.

Physikalisch-Technische Bundesanstalt • Bundesallee 100 • D-38116 Braunschweig



# Physikalisch-Technische Bundesanstalt



Braunschweig und Berlin

Anlage zur EG-Baumusterprüfbescheinigung PTB 04 ATEX 2107 X

Summenleistung $\Sigma P_i$	Umgebungstemperatur an der Elektronik
1,3 W	-20 ... +40 °C
1,2 W	-20 ... +60 °C
1,0 W	-20 ... +80 °C

Der Prozessdruck der Medien bzw. die Mediumtemperatur muss bei Anwendungen, die Kategorie-1-Betriebsmittel erfordern, zwischen 0,8 bis 1,1 bar bzw. -20 ... +60 °C liegen (atmosphärische Bedingungen). Wird von diesen oben genannten Einsatzbedingungen am Sensorelement abgewichen, ist zu beachten, dass der Sensor (auch im Störfall) keine eigene Erwärmung aufweist und dass der sichere Betrieb der Anlage im Hinblick auf Drücke/Temperaturen der verwendeten Stoffe dem Betreiber obliegt. Hierbei sind die Kenndaten des Herstellers zu beachten.

(16) Prüfbericht PTB Ex 04-24333

(17) Besondere Bedingungen

- Da die Versorgungs- und Datenstromkreise der Füllstandsensoren betriebsmäßig geerdet sind, ist längs des Leitungszuges der Versorgungs- und Datenstromkreise innerhalb und außerhalb des explosionsgefährdeten Bereiches Potentialausgleich zu errichten.
- Werden die Füllstandsensoren mit Kunststoffschwimmern ausgerüstet, so dürfen sie nur in explosionsgefährdeten Bereichen errichtet werden, die Betriebsmittel der Kategorie 1 mit der Betriebsmittelgruppe IIA erfordern.

(18) Grundlegende Sicherheits- und Gesundheitsanforderungen

erfüllt durch Übereinstimmung mit den vorgenannten Normen

Zertifizierungsstelle Explosionsschutz  
Im Auftrag

Braunschweig, 15. Dezember 2004

Dr.-Ing. U. Johannsmeyer  
Regierungsdirektor



Seite 3/3

EG-Baumusterprüfbescheinigungen ohne Unterschrift und ohne Siegel haben keine Gültigkeit.  
Diese EG-Baumusterprüfbescheinigung darf nur unverändert weiterverbreitet werden.  
Auszüge oder Änderungen bedürfen der Genehmigung der Physikalisch-Technischen Bundesanstalt.

Physikalisch-Technische Bundesanstalt • Bundesallee 100 • D-38116 Braunschweig

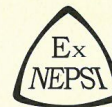

## EXPLOSION PROTECTION CERTIFICATE OF CONFORMITY

Cert NO.GYJ15.1046

This is to certify that the product

M Series Magnetostrictive Level Plus Liquid Level  
 Transmitter

manufactured by **MTS Systems Corporation Sensors Division**

(Address:3001 Sheldon Drive, Cary, NC 27513, USA)

which model is **USTD II [||||] series**

Ex marking **Ex ia II C T4 Ga**

product standard /

drawing number **280324**

has been inspected and certified by NEPSI, and that it conforms

to **GB 3836.1-2010,GB 3836.4-2010,GB 3836.20-2010**

This Approval shall remain in force until **2020.03.05**

- Remarks**
- 1.Conditions for safe use are specified in the attachment to this certificate.
  - 2.Model designation is specified in the attachment to this certificate.
  - 3.Intrinsic safety parameters specified in the attachment to this certificate.
  - 4.This certificate is also applicable for the product with the same type manufactured by Beijing Bright Automatic Measuring System Co., Ltd. (address: Xingye Building, No.10 Baifuquan Road, Science Park, Changping, Beijing China 102200)

**Director**



**National Supervision and Inspection Centre for  
 Explosion Protection and Safety of Instrumentation**

Issued Date **2015.03.06**

This Certificate is valid for products compatible with the documents and samples approved by NEPSI.

103 Cao Bao Road  
 Shanghai 200233, China

<http://www.nepsi.org.cn>  
 Email: [info@nepsi.org.cn](mailto:info@nepsi.org.cn)

Tel: +86 21 64368180  
 Fax: +86 21 64844580





Document Part Number: 550980 Revision F, 02/2016

MTS, Temposonics and Level Plus are registered trademarks of MTS Systems Corporation. All other trademarks are the property of their respective owners. Printed in USA. Copyright © 2016 MTS Systems Corporation. All Rights Reserved in all media.

All specifications are subject to change. Contact MTS for specifications and engineering drawings that are critical to your application. Drawings contained in this document are for reference only. Go to <http://www.mtssensors.com> for the latest product information.



**MTS Systems Corporation  
Sensors Division**

3001 Sheldon Drive  
Cary, North Carolina,  
27513, USA  
Tel.: +1-800-633-7609  
Fax: +1-919-677-2343  
+1-800-498-4442  
e-mail: [info.us@mtssensors.com](mailto:info.us@mtssensors.com)  
<http://www.mtssensors.com>

**MTS Sensor Technologie  
GmbH & Co. KG**

Auf dem Schüffel 9  
D - 58513 Lüdenscheid, Germany  
Tel.: +49-2351-9587-0  
Fax: +49-2351-56491  
e-mail: [info.de@mtssensors.com](mailto:info.de@mtssensors.com)  
<http://www.mtssensors.com>

**MTS Sensors Technology  
Corporation**

737 Aihara-cho, Machida-shi  
Tokyo 194-0211, Japan  
Tel.: +81-42-775-3838  
Fax: +81-42-775-5516  
e-mail: [info.jp@mtssensors.com](mailto:info.jp@mtssensors.com)  
<http://www.mtssensors.com>