

Data Sheet

GB-M / GB-T Analog Magnetostrictive Linear Position Sensors

- Sensor element and electronics can be changed
- Flat & compact sensor electronics housing
- Electrical connection is freely rotatable

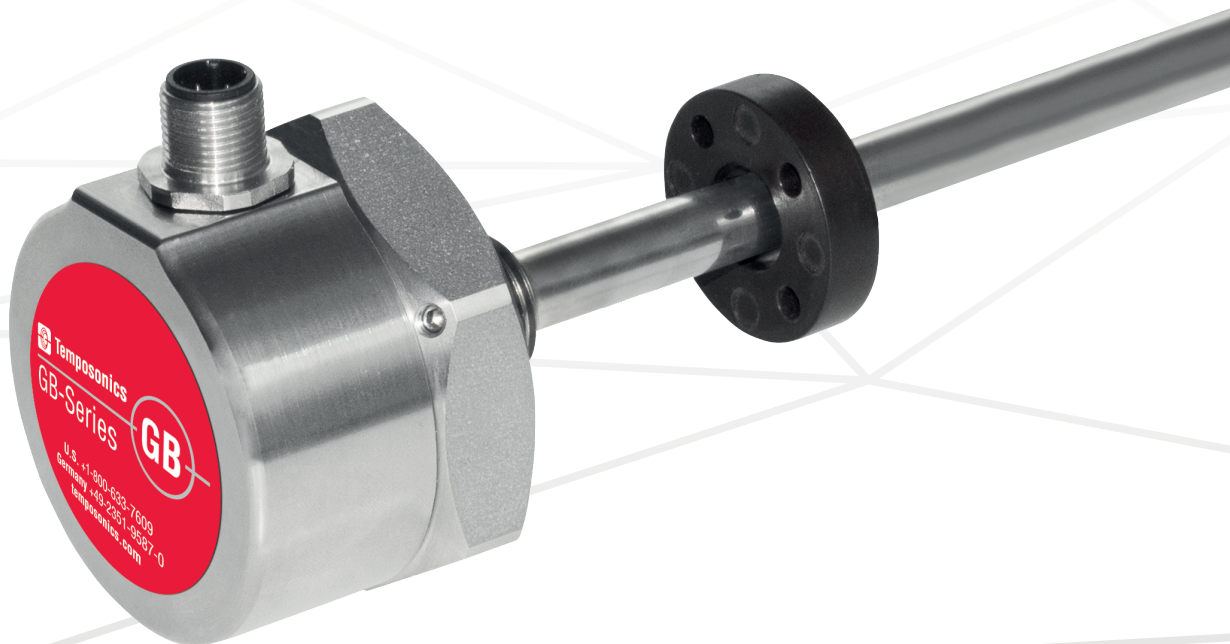

MEASURING TECHNOLOGY

The absolute, linear position sensors provided by Temposonics rely on the company's proprietary magnetostrictive technology, which can determine position with a high level of precision and robustness. Each Temposonics position sensor consists of a ferromagnetic waveguide, a position magnet, a strain pulse converter and supporting electronics. The magnet, connected to the object in motion in the application, generates a magnetic field at its location on the waveguide. A short current pulse is applied to the waveguide. This creates a momentary radial magnetic field and torsional strain on the waveguide. The momentary interaction of the magnetic fields releases a torsional strain pulse that propagates the length of the waveguide. When the ultrasonic wave reaches the end of the waveguide it is converted into an electrical signal. Since the speed of the ultrasonic wave in the waveguide is precisely known, the time required to receive the return signal can be converted into a linear position measurement with both high accuracy and repeatability.

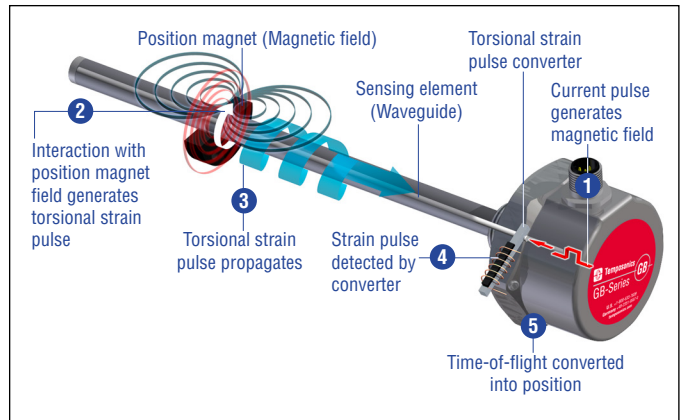

Fig. 1: Time-of-flight based magnetostrictive position sensing principle

GB-M/GB-T SENSOR

Robust, non-contact and wear free, the Temposonics linear position sensors provide the best durability and accurate position measurement solutions in harsh industrial environments. The high quality of the in-house manufactured waveguide forms the basis for precise measurements. The position magnet is mounted on the moving machine part and travels non-contact over the sensor rod with the built-in waveguide.

The GB-M/GB-T is an extension of the Temposonics® GB-Series. Its compact housing can be easily mounted, even if there is only limited space. Due to the high temperature resistance, no measures for cooling the sensor have to be taken – saving you time and work. Further advantages of the GB-M/GB-T sensor are:



TURN ME.

The sensor electronics housing with its electrical connection can be rotated 360 degrees after mounting to easily achieve the necessary connection orientation.



REPLACE ME.

If needed, the sensor element and electronics can be replaced without interrupting the hydraulic circuit – resulting in lower maintenance costs and reduced downtime.

PROGRAM ME.

The start position and end position of the measurement range are programmable, e.g. via programming kit, allowing users to adjust to meet the application requirements.



TECHNICAL DATA

Output	
Voltage	0...10 VDC and 10...0 VDC (minimum load controller: > 5 kΩ)
Current	4(0)...20 mA or 20...4(0) mA (minimum/maximum load: 0 / 500 Ω)
Programming	Programming of set points using optional accessories
Measured value	Position
Measurement parameters	
Resolution	16 bit (minimum 1 μm depending on stroke length) ¹
Cycle time	≤ 1200 mm: 0.5 ms ≤ 2400 mm: 1.0 ms > 2400 mm: 2.0 ms
Linearity ²	≤ ±0.02 % F.S. (minimum ±60 μm) typical
Repeatability	≤ ±0.005 % F.S. (minimum ±20 μm) typical
Operating conditions	
Operating temperature	−40...+90 °C (−40...+194 °F); options: −40...+75 °C (+167 °F)/−40...+100 °C (+212 °F)
Ingress protection	IP67 (if mating connectors are correctly fitted) IP68 (for cable outlet)
Shock test	100 g (single shock), IEC standard 60068-2-27
Vibration test	15 g/10...2000 Hz, IEC standard 60068-2-6 (resonance frequencies excluded)
EMC test	Electromagnetic emission according to EN 61000-6-4 Electromagnetic immunity according to EN 61000-6-2 The sensor meets the requirements of the EU directives and is marked with CE
Operating pressure	350 bar (5076 psi), 700 bar (10153 psi) peak (at 10 × 1 min)
Magnet movement velocity	Any
Design / Material	
Sensor electronics housing ³	Stainless steel 1.4305 (AISI 303)
Flange	Stainless steel 1.4305 (AISI 303)
Sensor rod	Stainless steel 1.4306; 1.4307 (AISI 304L)
Stroke length	25...3250 mm (1...128 in.)
Mechanical mounting	
Mounting position	Any
Mounting instruction	Please consult the technical drawings and the operation manual (document number: 551511)
Electrical connection	
Connection type	M12 (5 pin) male connector M16 (6 pin) male connector Cable outlet
Operating voltage	+24 VDC (−15/+20 %)
Ripple	≤ 0.28 V _{pp}
Current consumption	100 mA typical, dependent on stroke length
Dielectric strength	500 VDC (DC ground to machine ground)
Polarity protection	Up to −30 VDC
Overvoltage protection	Up to 36 VDC

1/ The internal digital value is measured through a 16-bit D/A converter and transferred into a proportional, analog current or voltage signal

2/ With position magnet # 251 416-2

3/ For option **H** (−40...+100 °C / −40...+212 °F) an aluminum cover plate is used

TECHNICAL DRAWING

M12 connector (example: With flat-faced flange)

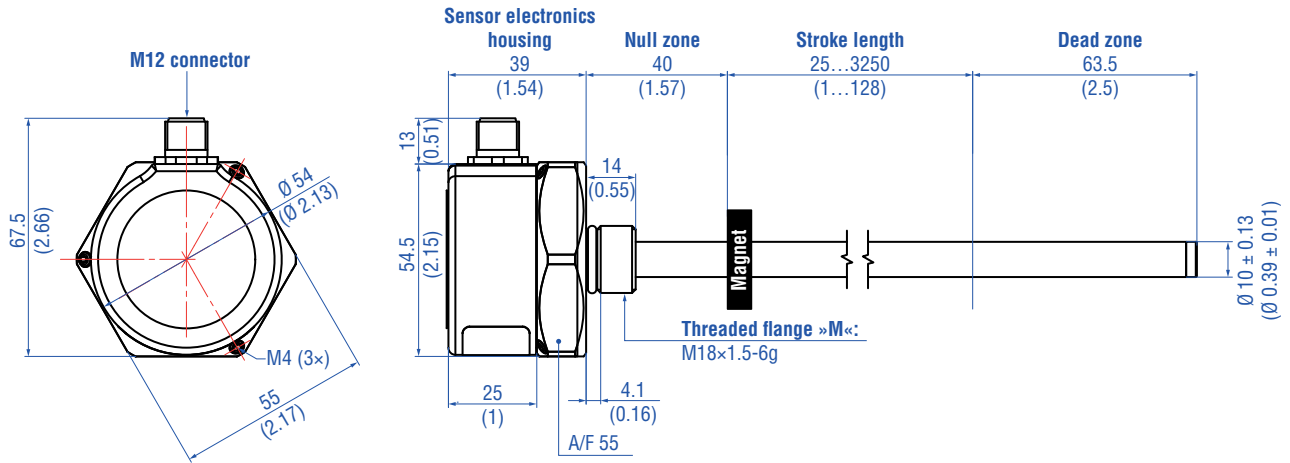

M16 connector (example: With raised-faced flange)

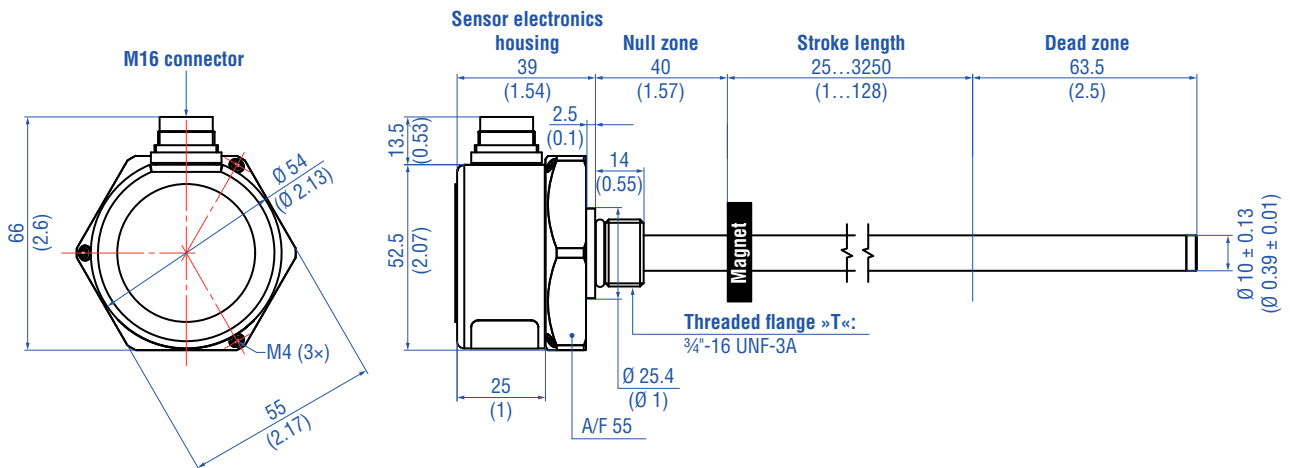

Cable outlet (example: With flat-faced flange)

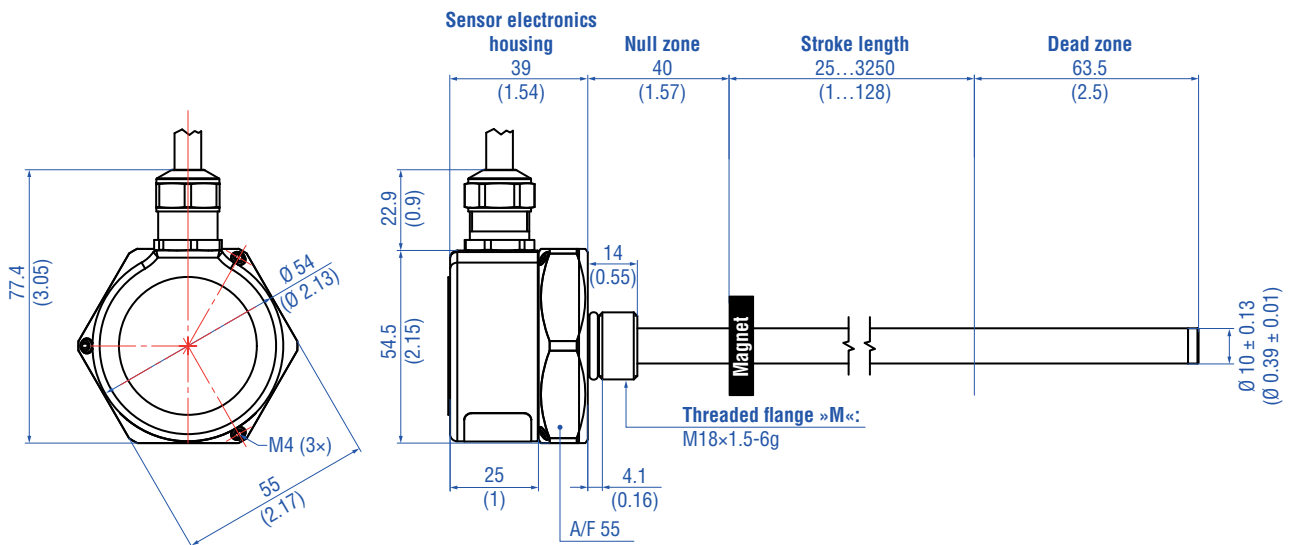

Controlling design dimensions are in millimeters and measurements in () are in inches

Fig. 2: Temposonics® GB-M / GB-T with ring magnet

CONNECTOR WIRING

D34 (for outputs: V0, A0, A1, A2, A3 in order code)			
Signal + power supply			
M12 male connector (A-coded)	Pin	Voltage	Current
 <p>View on sensor</p>	1	+24 VDC (-15 / +20 %)	+24 VDC (-15 / +20 %)
	2	0...10 VDC	4(0)...20 mA or 20... 4(0) mA
	3	DC Ground (0 V)	DC Ground (0 V)
	4	10...0 VDC	Not connected ⁴
	5	DC Ground	DC Ground

Fig. 3: Connector wiring D34 (M12) for outputs V0, A0, A1, A2 and A3

D34 (for output: A4 in order code)		
Signal + power supply		
M12 male connector (A-coded)	Pin	Current
 <p>View on sensor</p>	1	+24 VDC (-15 / +20 %)
	2	4...20 mA ⁵
	3	DC Ground (0 V)
	4	20...4 mA
	5	DC Ground

Fig. 6: Connector wiring D34 (M12) for output A4

D60 (for outputs: V0, A0, A1, A2, A3 in order code)			
Signal + power supply			
M16 male connector	Pin	Voltage	Current
 <p>View on sensor</p>	1	0...10 VDC	4(0)...20 mA or 20... 4(0) mA
	2	DC Ground	DC Ground
	3	10...0 VDC	Not connected ⁴
	4	DC Ground	DC Ground
	5	+24 VDC (-15 / +20 %)	+24 VDC (-15 / +20 %)
	6	DC Ground (0 V)	DC Ground (0 V)

Fig. 4: Connector wiring D60 (M16) for outputs V0, A0, A1, A2 and A3

D60 (for output: A4 in order code)		
Signal + power supply		
M16 male connector	Pin	Current
 <p>View on sensor</p>	1	4...20 mA ⁵
	2	DC Ground
	3	20...4 mA
	4	DC Ground
	5	+24 VDC (-15 / +20 %)
	6	DC Ground (0 V)

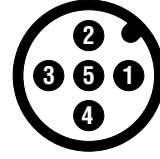
Fig. 7: Connector wiring D60 (M16) for output A4

HXX / TXX / VXX (for outputs: V0, A0, A1, A2, A3 in order code)			
Signal + power supply			
Cable	Color	Voltage	Current
	GY	0...10 VDC	4(0)...20 mA or 20... 4(0) mA
	PK	DC Ground	DC Ground
	YE	10...0 VDC	Not connected ⁴
	GN	DC Ground	DC Ground
	BN	+24 VDC (-15 / +20 %)	+24 VDC (-15 / +20 %)
	WH	DC Ground (0 V)	DC Ground (0 V)

Fig. 5: Connector wiring cable outlet for outputs V0, A0, A1, A2 and A3

HXX / TXX / VXX (for output: A4 in order code)		
Signal + power supply		
Cable	Color	Current
	GY	4...20 mA ⁵
	PK	DC Ground
	YE	20...4 mA
	GN	DC Ground
	BN	+24 VDC (-15 / +20 %)
	WH	DC Ground (0 V)

Fig. 8: Connector wiring cable outlet for output A4

^{4/} Connection necessary for programming with hand or cabinet programmer

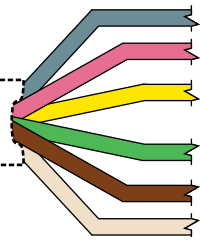
^{5/} Connect the first output at low-resistance

FREQUENTLY ORDERED ACCESSORIES – Additional options available in our [Accessories Guide](#)  [551444](#)

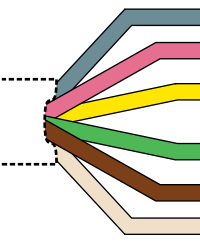
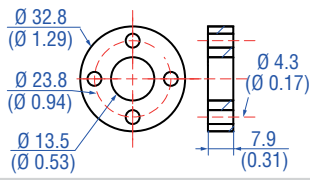
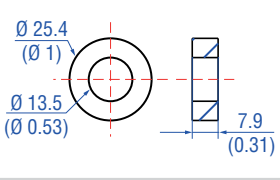
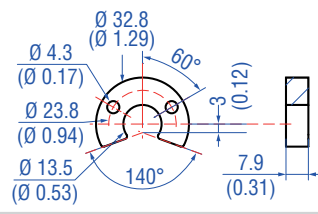
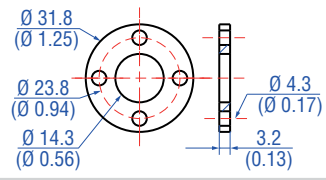
Position magnets		Magnet spacer	
 <p>Technical drawing of Ring magnet OD33 showing dimensions: outer diameter 32.8 (1.29), inner diameter 23.8 (0.94), hole diameter 13.5 (0.53), hole offset 4.3 (0.17), and thickness 7.9 (0.31).</p>	 <p>Technical drawing of Ring magnet OD25.4 showing dimensions: outer diameter 25.4 (1), inner diameter 13.5 (0.53), and thickness 7.9 (0.31).</p>	 <p>Technical drawing of U-magnet OD33 showing dimensions: outer diameter 32.8 (1.29), hole diameter 4.3 (0.17), hole offset 23.8 (0.94), hole diameter 13.5 (0.53), hole offset 14.3 (0.56), thickness 7.9 (0.31), and a 60-degree angle.</p>	 <p>Technical drawing of Magnet spacer showing dimensions: outer diameter 31.8 (1.25), inner diameter 23.8 (0.94), hole diameter 14.3 (0.56), hole offset 4.3 (0.17), and thickness 3.2 (0.13).</p>
<p>Ring magnet OD33 Part no. 201 542-2</p> <p>Material: PA ferrite GF20 Weight: Approx. 14 g Surface pressure: Max. 40 N/mm² Fastening torque for M4 screws: 1 Nm Operating temperature: -40...+105 °C (-40...+221 °F)</p>	<p>Ring magnet OD25.4 Part no. 400 533</p> <p>Material: PA ferrite Weight: Approx. 10 g Surface pressure: Max. 40 N/mm² Operating temperature: -40...+105 °C (-40...+221 °F)</p>	<p>U-magnet OD33 Part no. 251 416-2</p> <p>Material: PA ferrite GF20 Weight: Approx. 11 g Surface pressure: Max. 40 N/mm² Fastening torque for M4 screws: 1 Nm Operating temperature: -40...+105 °C (-40...+221 °F)</p>	<p>Magnet spacer Part no. 400 633</p> <p>Material: Aluminum Weight: Approx. 5 g Surface pressure: Max. 20 N/mm² Fastening torque for M4 screws: 1 Nm</p>

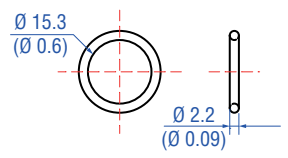
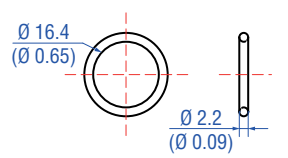
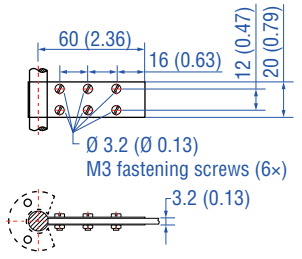
O-rings		Optional installation hardware
 <p>Technical drawing of O-ring for threaded flange M18x1.5-6g showing dimensions: outer diameter 15.3 (0.6) and thickness 2.2 (0.09).</p>	 <p>Technical drawing of O-ring for threaded flange 3/4-16 UNF-3A showing dimensions: outer diameter 16.4 (0.65) and thickness 2.2 (0.09).</p>	 <p>Technical drawing of Fixing clip showing dimensions: length 60 (2.36), hole diameter 3.2 (0.13), and hole offset 16 (0.63). It also shows a detail of the clip with 6 M3 fastening screws.</p>
<p>O-ring for threaded flange M18x1.5-6g Part no. 401 133</p> <p>Material: Fluoroelastomer Durometer: 75 ± 5 Shore A Operating temperature: -40...+204 °C (-40...+400 °F)</p>	<p>O-ring for threaded flange 3/4"-16 UNF-3A Part no. 560 315</p> <p>Material: Fluoroelastomer Durometer: 75 ± 5 Shore A Operating temperature: -40...+204 °C (-40...+400 °F)</p>	<p>Fixing clip Part no. 561 481</p> <p>Application: Used to secure sensor rods (Ø 10 mm (Ø 0.39 in.)) when using an U-magnet or block magnet Material: Brass, non-magnetic</p>

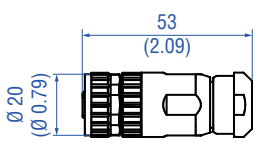
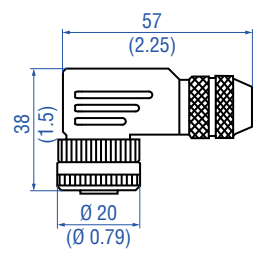
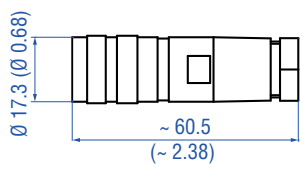
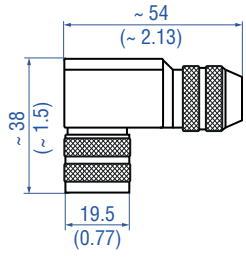
Cable connectors ⁶			
 <p>Technical drawing of M12 A-coded female connector (4 pin/5 pin), straight showing dimensions: length 53 (2.09) and cable diameter 20 (0.79).</p>	 <p>Technical drawing of M12 A-coded female connector (5 pin), angled showing dimensions: length 57 (2.25), cable diameter 20 (0.79), and angled length 38 (1.5).</p>	 <p>Technical drawing of M16 female connector (6 pin), straight showing dimensions: length ~60.5 (~2.38) and cable diameter 17.3 (0.68).</p>	 <p>Technical drawing of M16 female connector (6 pin), angled showing dimensions: length ~54 (~2.13), cable diameter 19.5 (0.77), and angled length ~38 (~1.5).</p>
<p>M12 A-coded female connector (4 pin/5 pin), straight Part no. 370 677</p> <p>Material: GD-Zn, Ni Termination: Screw Contact insert: CuZn Cable Ø: 4...8 mm (0.16...0.31 in.) Wire: 1.5 mm² Operating temperature: -30...+85 °C (-22...+185 °F) Ingress protection: IP67 (correctly fitted) Fastening torque: 0.6 Nm</p>	<p>M12 A-coded female connector (5 pin), angled Part no. 370 678</p> <p>Material: GD-Zn, Ni Termination: Screw; max. 0.75 mm² Contact insert: CuZn Cable Ø: 5...8 mm (0.2...0.31 in.) Wire: 0.75 mm² (18 AWG) Operating temperature: -25...+85 °C (-13...+185 °F) Ingress protection: IP67 (correctly fitted) Fastening torque: 0.4 Nm</p>	<p>M16 female connector (6 pin), straight Part no. 370 423</p> <p>Material: Zinc nickel plated Termination: Solder Cable Ø: 6...8 mm (0.24...0.31 in.) Operating temperature: -40...+100 °C (-40...+212 °F) Ingress protection: IP65/IP67 (correctly fitted) Fastening torque: 0.6 Nm</p>	<p>M16 female connector (6 pin), angled Part no. 370 460</p> <p>Material: Zinc nickel plated Termination: Solder Cable Ø: 6...8 mm (0.24...0.31 in.) Wire: 0.75 mm² (20 AWG) Operating temperature: -40...+95 °C (-40...+203 °F) Ingress protection: IP67 (correctly fitted) Fastening torque: 0.6 Nm</p>

^{6/} Follow the manufacturer's mounting instructions when connecting the connectors

Cables

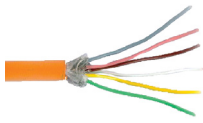

PUR cable
Part no. 530 052

Name of cable in order code: **H**
Material: PUR jacket; orange
Features: Twisted pair, shielded, highly flexible, halogen free, suitable for drag chains, mostly oil & flame resistant
Cable Ø: 6.4 mm (0.25 in.)
Cross section: $3 \times 2 \times 0.25 \text{ mm}^2$
Bending radius: $5 \times D$ (fixed installation)
Operating temperature: $-30 \dots +80 \text{ }^\circ\text{C}$ ($-22 \dots +176 \text{ }^\circ\text{F}$)

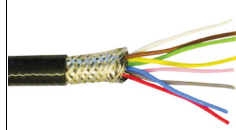

Teflon® cable
Part no. 530 112

Name of cable in order code: **T**
Material: Teflon® jacket; black
Features: Twisted pair, shielded, flexible, high thermal resistance, mostly oil & acid resistant
Cable Ø: 7.6 mm (0.3 in.)
Cross section: $4 \times 2 \times 0.25 \text{ mm}^2$
Bending radius: $8 - 10 \times D$ (fixed installation)
Operating temperature: $-100 \dots +180 \text{ }^\circ\text{C}$ ($-148 \dots +356 \text{ }^\circ\text{F}$)



Silicone cable
Part no. 530 113

Name of cable in order code: **V**
Material: Silicone jacket; red
Features: Twisted pair, shielded, highly flexible, halogen free, high thermal resistance
Cable Ø: 7.2 mm (0.28 in.)
Cross section: $3 \times 2 \times 0.25 \text{ mm}^2$
Bending radius: $5 \times D$ (fixed installation)
Operating temperature: $-50 \dots +180 \text{ }^\circ\text{C}$ ($-58 \dots +356 \text{ }^\circ\text{F}$)

Programming tools



Hand programmer for analog output
Part no. 253 124

Easy teach-in-setups of stroke length and direction on desired zero / span positions. For sensors with 1 magnet.



Cabinet programmer for analog output
Part no. 253 408

Features snap-in mounting on standard DIN rail (35 mm). This programmer can be permanently mounted in a control cabinet and includes a program/run switch. For sensors with 1 magnet.



Programming kit
Part no. 254 555

Kit includes:
1 × interface converter box
1 × power supply
1 × cable (60 cm) with M12 female connector (5 pin), straight – D-sub female connector (9 pin), straight
1 × cable (60 cm) with M16 female connector (6 pin), straight – D-sub female connector (9 pin), straight
1 × cable (60 cm) with 3 × terminal clamp – D-sub female connector (9 pin), straight
1 × USB cable

Software is available at:
www.mtssensors.com

ORDER CODE

1	2	3	4	5	6	7	8	9	10	11	12	13	14	15	16	
G	B										1				C	
a	b	c						d	e	f	g	h				

a	Sensor model
G B	Rod

b	Design
B	Base unit for threaded flanges »M« and »T«
GB rod-style sensor with housing material 1.4305 (AISI 303) and rod material 1.4306 / 1.4307 (AISI 304L)	
M	Threaded flange with flat-face, M18×1.5-6g
T	Threaded flange with raised-faced, ¾"-16 UNF-3A

c	Stroke length	
X X X X M	0025...3250 mm	
X X X X U	001.0...128.0 in.	
Standard stroke length (mm)*		Ordering steps
25... 500 mm		5 mm
500... 750 mm		10 mm
750...1000 mm		25 mm
1000...2500 mm		50 mm
2500...3250 mm		100 mm
Standard stroke length (in.)*		Ordering steps
1... 20 in.		0.2 in.
20... 30 in.		0.5 in.
30... 40 in.		1.0 in.
40...100 in.		2.0 in.
100...128 in.		4.0 in.

d	Connection type
D 3 4	M12 (5 pin) male connector (Note the operating temperature of the connector)
D 6 0	M16 (6 pin) male connector (Note the operating temperature of the connector)
H X X	H01...H10 (1...10 m) ⁷ PUR cable (part no. 530 052) H03...H33 (3...33 ft) ⁷ PUR cable (part no. 530 052) (Note the operating temperature of the cable)
T X X	T01...T10 (1...10 m) ⁷ Teflon® cable (part no. 530 112) T03...T33 (3...33 ft) ⁷ Teflon® cable (part no. 530 112)
V X X	V01...V10 (1...10 m) ⁷ Silicone cable (part no. 530 113) V03...V33 (3...33 ft) ⁷ Silicone cable (part no. 530 113)

e	Operating voltage
1	+24 VDC (-15 / +20 %)

f	Output
V 0	0...10 VDC and 10...0 VDC
A 0	4...20 mA
A 1	20...4 mA
A 2	0...20 mA
A 3	20...0 mA
A 4	4...20 mA and 20...4 mA

g	Operating temperature
H	-40...+100 °C (-40...+212 °F)
S	-40...+90 °C (-40...+194 °F)
L	-40...+75 °C (-40...+167 °F)

h	Programming
C	Via cable

DELIVERY

	GB-B: Sensor	GB-M / GB-T: Sensor O-ring	Accessories have to be ordered separately.
---	------------------------	---	--

Manuals, Software & 3D Models available at:
www.temposonics.com

* / Non standard stroke lengths are available; must be encoded in 5 mm / 0.1 in. increments

⁷ / Encode in meters if using metric stroke length. Encode in feet if using US customary stroke length

Trademarks and trade names are those of their respective owners.

UNITED STATES
Temposonics, LLC
Americas & APAC Region
3001 Sheldon Drive
Cary, N.C. 27513
Phone: +1 919 677-0100
E-mail: info.us@temposonics.com

GERMANY
Temposonics
GmbH & Co. KG
EMEA Region & India
Auf dem Schüffel 9
58513 Lüdenscheid
Phone: +49 2351 9587-0
E-mail: info.de@temposonics.com

ITALY
Branch Office
Phone: +39 030 988 3819
E-mail: info.it@temposonics.com

FRANCE
Branch Office
Phone: +33 6 14 060 728
E-mail: info.fr@temposonics.com

UK
Branch Office
Phone: +44 79 21 83 05 86
E-mail: info.uk@temposonics.com

SCANDINAVIA
Branch Office
Phone: +46 70 29 91 281
E-mail: info.sca@temposonics.com

CHINA
Branch Office
Phone: +86 21 2415 1000 / 2415 1001
E-mail: info.cn@temposonics.com

JAPAN
Branch Office
Phone: +81 3 6416 1063
E-mail: info.jp@temposonics.com

Document Part Number:
551838 Revision C (EN) 06/2022



temposonics.com